



Standard Test Method for Determination of the Impact Value (IV) of a Soil¹

This standard is issued under the fixed designation D 5874; the number immediately following the designation indicates the year of original adoption or, in the case of revision, the year of last revision. A number in parentheses indicates the year of last reapproval. A superscript epsilon (ϵ) indicates an editorial change since the last revision or reapproval.

1. Scope *

1.1 This test method covers the determination of the Impact Value (IV) of a soil either in the field or a test mold.

1.2 The standard test method, using a 4.5 kg (10 lbm) hammer, is suitable for, but not limited to, evaluating the strength of an unsaturated compacted fill, in particular pavement materials, soils, and soil-aggregates having maximum particle sizes less than 37.5 mm (1.5 in.).

1.3 By using a lighter 0.5 kg (1.1 lbm) hammer, this test method is applicable for evaluating lower strength soils such as fine grained cohesionless, highly organic, saturated, or highly plastic soils having a maximum particle size less than 9.5 mm (0.375 in.).

1.4 By performing laboratory test correlations for a particular soil using the 4.5 kg (10 lbm) hammer, IV may be correlated with an unsoaked California Bearing Ratio (CBR) or may be used to infer percentage compaction.

1.5 The values stated SI are to be regarded as the standard. The values stated in parentheses are given for information only.

1.6 All observed and calculated values shall conform to the guidelines for significant digits and rounding established in Practice D 6026. The method used to specify how data are collected, calculated, or recorded in this standard is not directly related to the accuracy to which the data can be applied in design or other uses or both. How one applies the results obtained using this standard is beyond its scope.

1.7 *This standard may involve hazardous materials, operations, and equipment. This standard does not purport to address all of the safety concerns, if any, associated with its use. It is the responsibility of the user of this standard to establish appropriate safety and health practices and determine the applicability of regulatory limitations prior to use.*

NOTE 1—The equipment and procedures contained in this test method are similar to those developed by B. Clegg in the 1970s at the University of Western Australia, Nedlands, Australia. Impact Value is also commonly known as Clegg Impact Value (CIV).

2. Referenced Documents

2.1 ASTM Standards:

- D 653 Terminology Relating to Soil, Rock, and Contained Fluids²
- D 698 Test Method for Laboratory Compaction Characteristics of Soils Using Standard Effort (12 400 ft lbf/ft³(600 kNm/m³))²
- D 1556 Test Method for Density of Soil in Place by the Sand-Cone Method²
- D 1557 Test Method for Laboratory Compaction Characteristics of Soils Using Modified Effort (56 000 ft lbf/ft³(2700 kNm/m³))²
- D 1883 Test Method for CBR (California Bearing Ratio) of Laboratory Compacted Soils²
- D 2167 Test Method for Density of Soil in Place by the Rubber-Balloon Method²
- D 2216 Method for Laboratory Determination of Water (Moisture) Content of Soil, Rock, and Soil-Aggregate Mixtures²
- D 2922 Test Methods for Density of Soil and Soil-Aggregates in Place by Nuclear Methods (Shallow Depth)²
- D 2937 Test Method for Density of Soil in Place by the Drive-Cylinder Method²
- D 3017 Test Method for Water Content of Soil and Rock in Place by Nuclear Methods (Shallow Depth)²
- D 3740 Practice for Minimum Requirements for Agencies Engaged in the Testing and/or Inspection of Soil and Rock as Used in Engineering Design and Construction²
- D 4643 Test Method for Determination of Water (Moisture) Content of Soil by the Microwave Oven Method²
- D 4959 Test Method for Determination of Water (Moisture) Content of Soil by Direct Heating Method²
- D 6026 Practice for Using Significant Digits in Geotechnical Data³

3. Terminology

3.1 *Definitions*—Except as listed below, all definitions are in accordance with Terminology D 653.

3.1.1 *impact value (IV), n*—the value expressed in units of tens of gravities (g) derived from the peak deceleration of a 4.5 kg (10 lbm) instrumented compaction hammer 50 mm (1.97 in.) in diameter free falling 450 mm (18 in.).

¹ This test method is under the jurisdiction of ASTM Committee D18 on Soil and Rock and is the direct responsibility of Subcommittee D18.08 on Special and Control Tests.

Current edition approved Sept. 10, 2002. Published December 2002. Originally published as D 5874–95. Last previous edition D 5874–95.

² *Annual Book of ASTM Standards*, Vol 04.08.

³ *Annual Book of ASTM Standards*, Vol 04.09.

*A Summary of Changes section appears at the end of this standard.

3.1.2 *light impact value (IV/L), n*—the IV derived from using a 0.5 kg (1.1 lbm) mass hammer 50 mm (1.97 in.) in diameter free falling 300 mm (12 in.).

3.1.3 *impact soil tester, n*—testing apparatus used to obtain an IV of a soil.

3.1.4 *target iv, n*—the desired strength, in terms of IV, to be achieved in the field for a particular material and construction process. This may also be referred to as *target strength*.

4. Summary of Test Method

4.1 The test apparatus is placed on the material to be tested either in a mold or on naturally occurring or compacted soil in the field. The hammer is raised to a set height and allowed to free fall. The instrumentation of the test apparatus displays a value in tens of gravities (*g*) of the peak deceleration of the hammer's impact as recorded by an accelerometer fitted to the top of the hammer body. A total of four blows of the hammer are applied on the same spot to determine the IV for each test performed.

4.2 A light hammer of 0.5 kg (1.1 lbm) may be used for softer conditions or fragile materials instead of the 4.5 kg (10 lbm) standard hammer to determine the IV. When used the resulting value is termed the Light Impact Value (IV/L).

5. Significance and Use

5.1 Impact Value, as determined using the standard 4.5 kg (10 lbm) hammer, has direct application to design and construction of pavements and a general application to earthworks compaction control and evaluation of strength characteristics of a wide range of materials, such as soils, soil aggregates, stabilized soil and recreational turf. Impact Value is one of the properties used to evaluate the strength of a layer of soil up to about 150 mm (6 in.) in thickness and by inference to indicate the compaction condition of this layer. Impact Value reflects and responds to changes in physical characteristics that influence strength. It is a dynamic force penetration property and may be used to set a strength parameter.

5.2 This test method provides immediate results in terms of IV and may be used for the process control of pavement or earthfill activities where the avoidance of delays is important and where there is a need to determine variability when statistically based quality assurance procedures are being used.

5.3 This test method does not provide results directly as a percentage of compaction but rather as a strength index value from which compaction may be inferred for the particular moisture conditions. From observations, strength either remains constant along the dry side of the compaction curve or else reaches a peak and declines rapidly with increase in water content slightly dry of optimum water content. This is generally between 95 and 98 % maximum dry density (see Fig. 1 and Fig. 2). A field target strength in terms of IV may be designated from laboratory testing or field trials for a desired density and water content. If testing is performed after compaction when conditions are such that the water content has changed from the critical value, determination of the actual water content by laboratory testing enables the field density to be inferred from regression equations using IV, density and water content.

NOTE 2—Impact Value may be used as a means to improve the

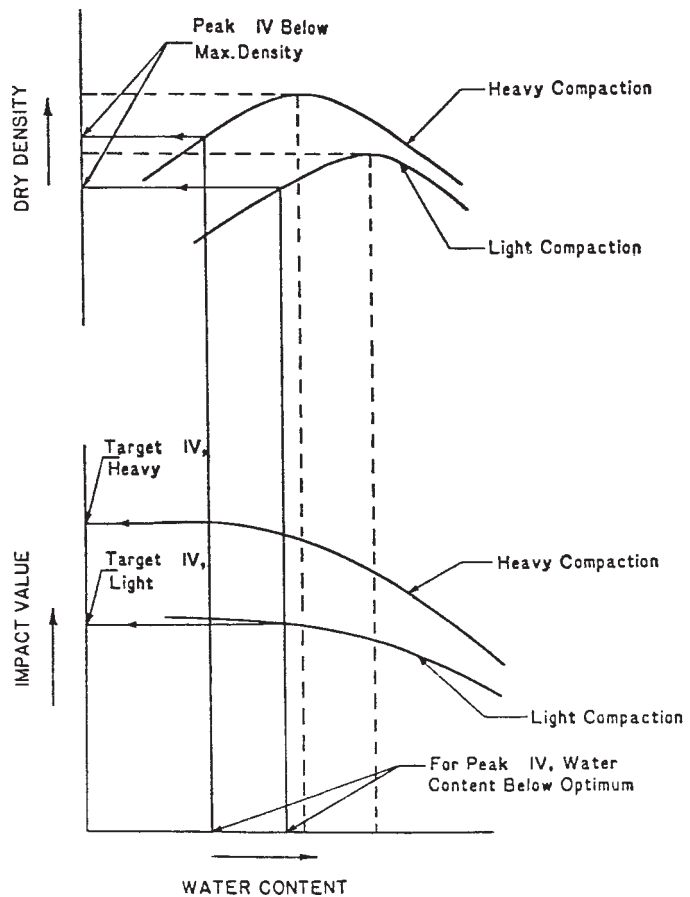

FIG. 1 Illustration of Target IV for Material With No Peak but Drop

compaction process by giving instant feedback on roller efficiency, uniformity, confirming the achievement of the target strength, and by inference the achieved density. When inferring density from IV, however, it should be considered as only indicative of density. Where strict acceptance on a density ratio basis is required, test methods that measure density directly shall be used.

5.4 This test method may be used to monitor strength changes during a compaction process or over time due to seasonal, environmental or traffic changes.

NOTE 3—For in-place soil strength evaluation where there may be a dry and hard surface layer (crust), testing both the crust and the underlying layer may be required.

5.5 The standard instrument is based on a 4.54 kg (10 lbm) compaction hammer using a 457.2 mm (18 in.) drop height. The hammer has been equipped with an accelerometer and instrumented using a peak hold electronic circuit to read the peak deceleration on impact. The circuitry is filtered electronically to remove unwanted frequencies and the peak deceleration is displayed in units of ten gravities (*g*) with the output below units of ten gravities truncated.

5.6 The peak deceleration on which IV is derived represents the area under the deceleration versus time curve which for most soils may be assumed as half a sinusoid. Applying double integration provides first the time velocity relationship and second, the time penetration relationship. As force is also directly related to deceleration, the IV therefore, represents both stress and penetration and may be taken as a direct measurement of stiffness or strength (see Fig. 3).

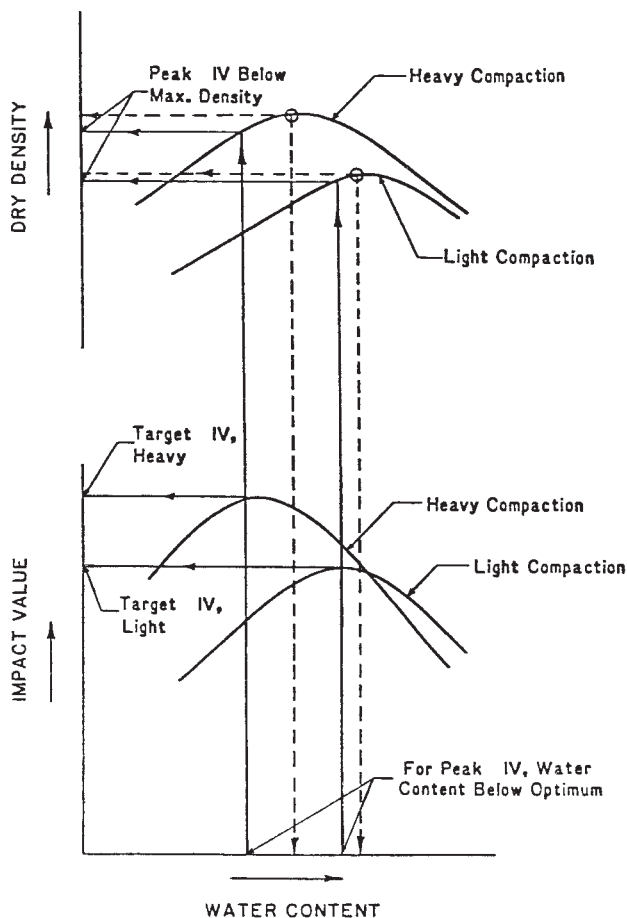

FIG. 2 Illustration of Target IV for Material With Pronounced Peak

5.7 Impact Value may be correlated with an unsoaked CBR.

5.8 Impact Value may be expressed as a hammer modulus, analogous with elastic modulus or deformation modulus.

5.9 The light hammer uses the same accelerometer and instrumentation as the standard hammer. The smaller mass of 0.5 kg (1.1 lbm) results in more sensitivity for lower strength materials compared to the standard mass; that is, the zero to 100 IV scale is expanded with this lighter hammer mass and provides more definition on softer materials. To avoid confusion, the IV of the light hammer is notated as IV/L.

5.10 Light Impact Value has applications for recreation turf hardness evaluation, where the condition of the surface affects ball bounce characteristics, the performance or injury potential to participants, and where more sensitivity compared to the standard hammer is required or an imprint left by the 4.5 kg (10 lbm) hammer or other test methods is undesirable, such as on a golf putting green.

NOTE 4—The agency performing this test method can be evaluated in accordance with Practice D 3740. Notwithstanding oil precision and bias contained in this test method, the precision of this test method is dependent on the competence of the personnel performing it and the suitability of the equipment and facilities used. Agencies that meet the criteria of Practice D 3740 are generally considered capable of competent and objective testing. Users of this test method are cautioned that compliance with Practice D 3740 does not assure reliable testing. Reliable testing depends on many factors, and Practice D 3740 provides a means of evaluating some of those factors.

Assumed Sinusoidal Deceleration vs. Time Curve

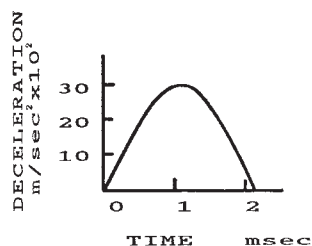

First Integration of Area under the Deceleration vs. Time Curve

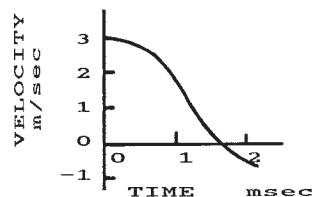

Second Integration

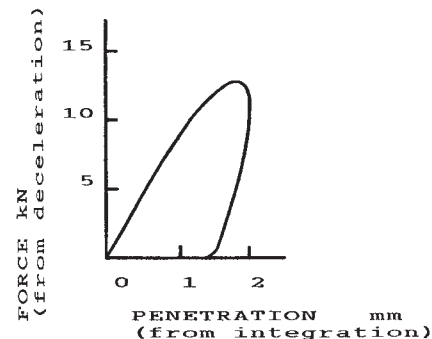
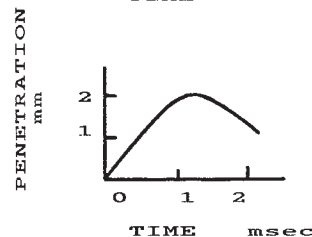

FIG. 3 Development of Force-Penetration from Deceleration Versus Time

6. Apparatus

6.1 *Impact Soil Tester*—A test apparatus consisting of a hammer, guide tube, and electronic instrumentation. Detailed information on the apparatus is contained in Annex A1. A typical configuration is shown in Fig. 4.

6.2 *Mold*—A 152.4 mm (6 in.) diameter mold conforming to the requirements of Test Methods D 698 Procedure C, D 1557 Procedure C, or D 1883 with a spacer disc.

6.2.1 Molds of other, typically larger, dimensions may be used but must be reported accordingly in the report.

NOTE 5—For a particular material, the smaller 101.6 mm (4 in.) mold may be used if it has been proven by a laboratory test comparison with the 152.4 mm (6 in.) mold that there is no significant difference in the IV results.

7. Procedure

7.1 *Operational Verification Checks*— Perform operational verification checks at the commencement of any testing program, after repair, or when the instrument is suspect using the operational check ring as follows.

7.1.1 Place the ring on a dry, grease free smooth hard surface of a solid massive object, such as a concrete floor over

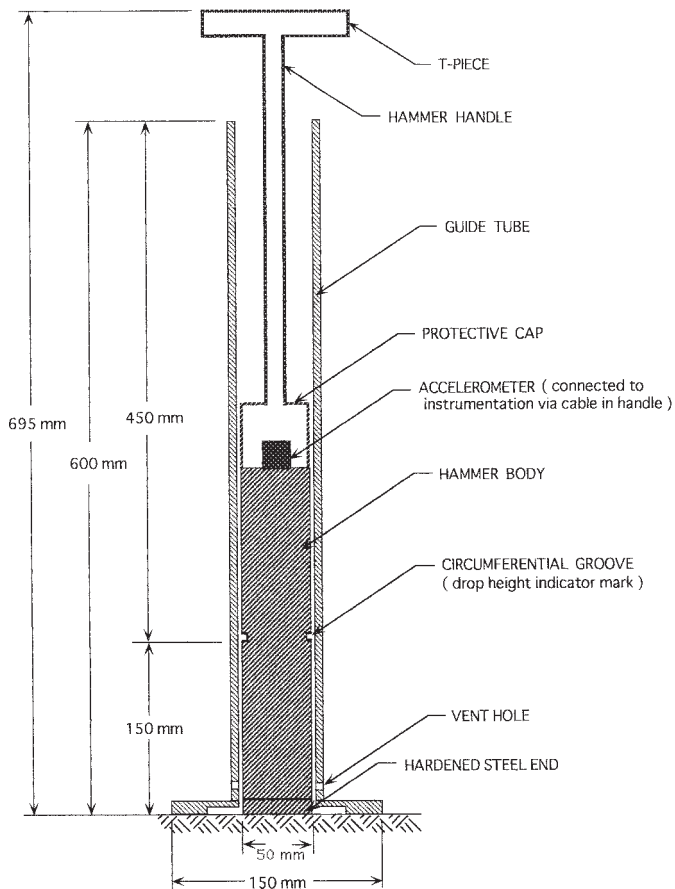

FIG. 4 Illustration (Cross Section) of a 4.5 kg Impact Soil Tester with Hammer at Rest in the Guide Tube

ground. Place the guide tube centrally over the ring and drop the hammer five times from the set height mark as described in A2.1.3 for the standard 4.5 kg hammer or A2.1.4 for the light 0.5 kg hammer. Operate the instrumentation so as to obtain five separate readings. If this operational check procedure gives significantly different values than shown on the ring, examine the dryness, cleanliness, smoothness and firmness of the support for the ring and the ring itself and review the operational check procedure and rerun the check at the same or another location. If the ring value is not satisfactorily achievable, an electronic check may be carried out according to the manufacturer's calibration instruction for the accelerometer.

NOTE 6—To avoid the possibility of damage to the electronics or the hammer, the impact soil tester should not be used directly on hard surfaces such as concrete or otherwise in such a way on materials that it would give results of more than 100 IV (1000 g).

NOTE 7—The impact energy provided by the 4.5 kg hammer can cause undesired damage to surfaces and materials such as brick or concrete paving slabs or smoothly prepared turf surfaces.

7.2 Determine an IV as follows.

7.2.1 The peak deceleration that is the highest of the four successive blows is taken as the IV. The maximum of the first four blows has been found through experiment and practice to be the simplest means by which to obtain consistent results. Analysis of the blow count has shown that the first blow or two may be considered as seating procedure as they create a

compacted wedge or hemisphere of soil that is subsequently forced into the body of the soil causing an increase in deceleration, that is, an increase in IV, as successive blows are applied. In general, deceleration remains practically unchanged after the third or fourth blow with additional blows continuing to produce a constant amount of penetration. If lower values occur with subsequent blows, this is due apparently to the hammer striking the sides of the indentation or by loose material falling onto the strike surface causing a bias in this direction.

7.2.2 Impact Values obtained from other blow counts, or an average thereof, shall be reported accordingly in the report.

7.3 *Field Procedure A*—If necessary, prepare the surface of the compacted or natural soil to be tested by lightly scuffing with the foot to remove loose surface material. Before beginning a test, ensure that the hammer strike face is clean of any soil build-up and that the guide tube is reasonably clean so as not to restrict a free fall. Place the impact soil tester in position with the guide tube base set on the ground. Steady the guide tube to hold vertical in place, activate the instrumentation, and apply four free falling blows in succession from the set height of drop. Take and record the highest value of the four blows as the IV.

NOTE 8—A method of securing the guide tube in a vertical position is for the operator to place a foot on the guide tube base and steady the guide tube with the lower leg or knee, or both. Raising of the hammer is done by the hand on the same side of the body as the foot securing the guide tube.

NOTE 9—For sloping sites, a level test surface may need to be prepared so that the guide tube base rests on the surface with the guide tube as near to vertical as possible.

7.4 *Field Procedure B*—Follow *Field Procedure A* but determine the water content of the material at a location 100 mm (4 in.) to 150 mm (6 in.) from the edge of the guide tube flange content. Determine the water content according to the applicable test methods listed in 2.1.

7.5 *Field Procedure C*—Follow *Field Procedure B* but determine also the density of the material at a location 100 mm (4 in.) to 150 mm (6 in.) from the edge of the guide tube flange. Determine the density according to the applicable test methods listed in 2.1.

7.6 *Mold Procedure*—Obtain a soil sample representative of that to be tested in the field and prepare a test specimen according to the requirements of either Test Method D 698 or D 1557. Prepare the test specimen at a water content and density at which it is desired to determine the IV. Compact the test specimen in a mold as given in 6.2. Perform the impact test on the compacted specimen in the mold with the base plate left attached to the mold. Before beginning a test, ensure that the hammer strike face is clean of any soil build-up and that the guide tube is reasonably clean so as not to restrict a free fall. To aid in centering and steadying the guide tube, replace the mold collar after trimming the surface of the compacted soil and brushing off loose material if necessary. Place the mold with the specimen on a firm, smooth base such that it cannot be rocked. Place the impact soil tester on the trimmed surface in a vertical position with the guide tube base set inside the mold collar or centered on the soil. Activate the instrumentation, and without moving the guide tube, apply four free falling blows in

succession from the standard height of drop. Take and record the highest value of the four blows as the IV.

8. Correlation of IV With Other Soil Properties and Determination of a Target IV

8.1 A *Target Strength*, for a particular soil, may be chosen from the following IV correlations. All procedures given below for determination of a Target IV are performed with a compaction curve according to either Test Method D 698 or D 1557. Each of the following three procedures apply to density or CBR correlations. Where CBR correlations are requested, a duplicate specimen is required for each of the following procedures, that is, an IV test is performed on one specimen and an unsoaked CBR test is carried out on the duplicate specimen.

8.1.1 *Target IV at Optimum Water Content Only*—After determining the optimum water content of the sample in accordance with either Test Method D 698 or D 1557, compact a specimen in a mold as described in 6.2 to the desired optimum water content and maximum dry unit weight or percent compaction using the specified compaction procedure from soil prepared to within $\pm 0.5\%$ of optimum water content. Obtain Target IV according to 7.6. If requested, obtain an unsoaked CBR according to Test Method D 1883 on a duplicate specimen.

8.1.2 *Target IV from a Range of Water Contents*—Determine the optimum water content of the sample according to either Test Method D 698 or D 1557. Prepare four specimens using the mold size as described in 6.2 at a range of water contents such that they bracket the optimum water content. The water contents shall vary about 2%. Compact each specimen using 100% compactive effort according to the nominated compaction method. Obtain an IV according to 7.6 for each specimen molded to produce a curve of IV versus water content. Determine the Target IV from the correlation curve at the point at which an increase in water content results in a corresponding loss of strength. If requested, obtain corresponding unsoaked CBRs on duplicate specimens and plot the IV versus CBR relationship.

8.1.3 *Target IV from a Range of Densities at Optimum Water Content*—Determine the maximum dry density and optimum water content of the sample according to either Test Method D 698 or D 1557. Compact four specimens all at optimum water content $\pm 0.5\%$ using the mold size as given in 6.2. Compact each specimen using a differing number of blows per layer for each specimen. Vary the number of blows per layer as necessary to prepare specimens having unit weights above and below the desired value, typically covering the range of 90 to 100% relative compaction. Specimens compacted at 56, 30, 20, and 10 blows per layer is satisfactory. Obtain an IV according to 7.6 for each specimen molded. Plot the IV versus the relative compaction at optimum water content. Determine the Target IV for the desired percent compaction from the correlation curve. If requested, obtain corresponding unsoaked CBRs on duplicate specimens and plot the IV versus CBR relationship.

9. Field Trial Procedure to Determine Target IV

9.1 This procedure determines a Target IV using a field trial to compact several test strips at differing water conditions using compaction procedures known to be capable of producing the required density level.

9.1.1 Uniformly mix the particular soil to be used in the field trial. Allow for field moisture curing before compacting if necessary according to standard water preparation practice for the particular soil. Prepare four test strips of uniform layer thickness at different water contents determined visually or predetermined by laboratory tests to bracket optimum water content. It is suggested that the test strips be not less than one roller width by five roller lengths (including the prime mover), and that testing be confined to a central three roller length section of each test strip. The layer thickness may be varied to suit the material type and compaction equipment being used. In general, a loose placed nominal layer thickness of 230 mm (9 in.) gives a final compacted layer thickness of 150 mm (6 in.).

9.1.2 For each test strip, randomly perform at least five IV tests after the second, fourth, eighth, and sixteenth successive roller pass. Calculate and record the mean IV for each set of impact tests for each test strip at the completion of each of the above designated number of roller passes. It is important that there is no significant change in the water content of the test strips throughout the trial.

9.1.3 Determine the field water content of each test strip at the completion of the field trial in accordance with either Test Method D 4643 or D 4959. Plot a correlation curve for the mean IV at the sixteenth roller pass for each test strip versus the water content. Determine the Target IV from the correlation curve at the point at which an increase in water content results in a corresponding loss of strength. The roller efficiency may be evaluated by comparing the number of roller passes versus the mean IV for each test strip at each water content.

9.1.4 If requested, perform a density test on each test strip after the second, fourth, eighth, and sixteenth roller passes. Determine density in accordance with any of these Test Methods: D 1556, D 2167, D 2937, or D 2922.

9.1.5 If requested, determine and record the field water content of each test strip after the second roller pass according to the applicable test methods listed in 2.1.

NOTE 10—The completion of the field trial after sixteen roller passes is nominal only and this number may need to be varied depending on the roller and material used. Experience, however, has shown that sixteen passes for a heavy roller achieves 100% modified compactive effort for finished layers up to 150 mm (6 in.) thickness.

10. Report

10.1 Report, as a minimum, the following information:

10.1.1 Date of test and procedure used,

10.1.2 Operator's name,

10.1.3 Test location, elevation, thickness of layer tested or other pertinent data to locate or identify the test,

10.1.4 Description or type of soil and, for field procedures, whether compacted or natural,

10.1.5 For *Field Procedure A*, the IV, or IV/L, of the soil (in units of ten gravities),

10.1.6 For *Field Procedure B*, the IV and water content,

10.1.7 For *Field Procedure C*, the IV, water content, and density,

10.1.8 For *Mold Procedure*, the IV, relative density, maximum dry density, water content and method used for preparation and compaction, either Test Method D 698 or D 1557. If another variation of compactive effort has been used, report a full description.

10.1.9 For *Target IV at Optimum Water Content Only*, report according to either Test Method D 698 or D 1557 as used, according to 10.1.8, and the Target IV. If an unsoaked CBR has been determined on a duplicate sample, report in addition according to Test Method D 1883.

10.1.10 For *Target IV from a Range of Water Contents*, report according to either Test Method D 698 or D 1557 as used, according to 10.1.8 for each specimen, the IV versus the water content correlation curve, and the determined Target IV. If unsoaked CBRs were obtained on corresponding duplicate specimens, report according to Test Method D 1883 and the IV versus CBR relationship.

10.1.11 For *Target IV from a Range of Densities at Optimum Water Content*, report according to either Test Method D 698 or D 1557 as used, according to 10.1.8 for each specimen, the IV versus the density correlation curve, and the determined Target IV. If unsoaked CBRs were obtained on corresponding duplicate specimens, report in addition according to Test Method D 1883 and the IV versus the CBR relationship.

10.1.12 For *9 Field Trial Procedure to Determine Target IV*, report for each test strip all the mean IVs and the corresponding number of roller passes, the water content at the completion of the field trial, and, if requested, the water content after the second roller pass. Plot the correlation curve of the mean IV at the sixteenth roller pass versus the water content. Report the determined Target IV, layer thickness at loose and compacted states, and the model number, type and mass of roller used. If requested to perform density tests, report the density test results.

10.1.13 Details of the test where other than the standard procedure is used such as mass or dimensions of hammer, height of drop, number of blows, selection of IV from the number of blows, recording in gravities (g) instead of IV units, mold size.

11. Precision and Bias

11.1 *Precision*—No formal round-robin testing using this test method to determine precision has been completed. Data from one source performing trial tests on the operational check ring found that the coefficient of variation for the instrument is around 2 % or better for good laboratory workshop conditions. Data from the same source for testing during roadwork construction found a coefficient of variation of 4 % for what was considered to represent the upper bound of job uniformity to a coefficient of variation of around 20 % for what was considered a very variable condition.

11.2 *Bias*—The limiting factor with respect to this test method is that of the inherent non-uniformity of the soil itself. There are no absolute values or standards for IV for soils against which this test method can be compared. This test method, therefore, has no determinable bias since the values obtained can only be defined in terms of the test method.

11.3 Pertinent data from users of this test method on precision is being sought.⁴

12. Keywords

12.1 acceptance test; clegg impact value; compaction control; impact soil test; impact test; impact test hammer; impact value; light impact value; soil test; stabilization testing; strength test; trench testing; turf testing

⁴ Please submit pertinent data to Subcommittee D18.08 for inclusion in the revision of this test method. Send your data to ASTM Headquarters, c/o D18.08 Subcommittee Chairman, 100 Barr Harbor Drive, West Conshohocken, PA 19428.

ANNEXES

(Mandatory Information)

A1. Apparatus

A1.1 The following sections provide additional specific details on the test apparatus described in this test method.

A2. Standard Hammer (4.5 kg)

A2.1 The standard hammer, consisting of a cylindrical steel hammer body, an accelerometer and handle assembly, shall have a mass of between 4.50 kg (9.92 lbm), and 4.60 kg (10.14 lbm) inclusive. A typical configuration is shown in Fig. 4 and Fig. A2.1. The end of the hammer with the striking face shall be hardened steel, circular, and planar. The hammer body shall have a diameter of 50 mm ± 0.2 mm (1.97 ± 0.008 in.). Typically the hammer body is inscribed with a circumferential

groove to mark the set height of drop as given in A2.1.3, or otherwise marked to achieve the desired drop height. An accelerometer rated at a minimum of 5000 gravities is securely fastened to the top of the hammer body and preferably covered with a protective cap. The hammer body has either a tubular handle or drop cord centrally coupled or fastened to the top of the protective cap above the accelerometer on the top of the hammer body. If the hammer has a drop cord instead of a

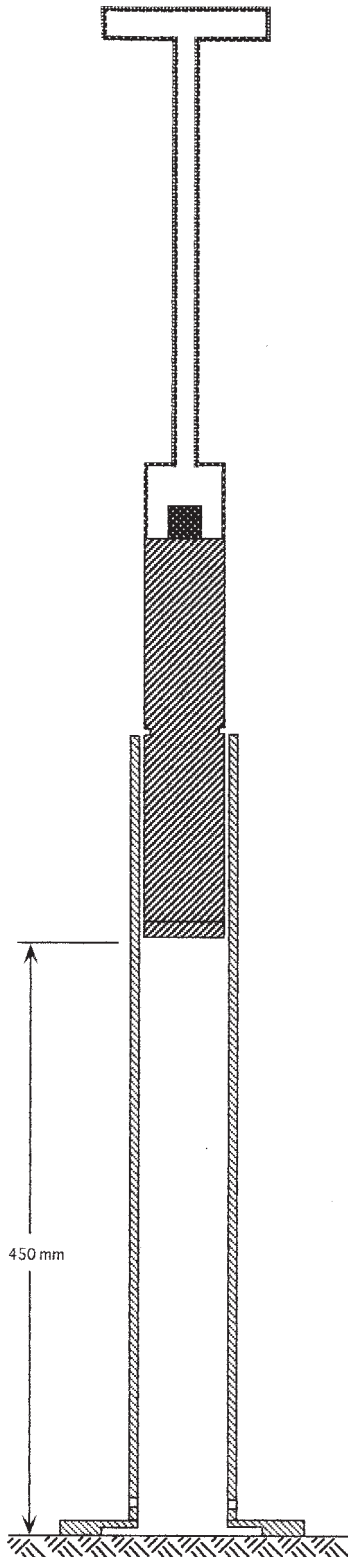

FIG. A2.1 Illustration (Cross Section) of a 4.5 kg Impact Soil Tester With Hammer in the Raised Position

electrical cable, and drop cord if used in place of a tubular handle, should be as short and light as practical. A cable length of 1 m (3 ft, 3 in.) is suitable for use with a hand held meter box. A tubular handle should terminate in a T-piece.

A2.1.1 The shaft of the handle may have a scale graduated in units of 2.5 mm (0.1 in.) with the scale reading in an upwards direction for at least twenty units and placed on the handle shaft so the zero is level with the top rim edge of the guide tube when the hammer is in the rest position with the underside of the hammer flush with the underside of the guide tube base. If desired, this scale may be used to measure to the nearest full unit the depth of residual penetration of the hammer into the soil so that data may be collected for residual surface penetration versus IV.

A2.1.2 *Electronic Instrumentation*—The impact soil tester is electronically instrumented to read and hold the peak deceleration of the hammer, filtered to limit the frequency to below 7 kHz, from zero to 1000 gravities ± 10 gravities, and displaying in units of IV (10 gravities) or alternately having the accelerometer attached by an electrical cable to an oscilloscope in such a way that the IV may be determined.

A2.1.3 *Guide Tube*—A vented guide tube of nominal 50.8 mm (2 in.) diameter, such as to not restrict a free fall of the hammer is used to control the height of drop between 450 mm (17.72 in.) and 460 mm (18.11 in.) inclusive for the 4.5 kg (10 lbm) hammer as measured from the underside of the hammer strike face when the hammer is in the raised position in the guide tube to the extreme underside of the guide tube base. The height of drop is indicated when the lower edge of the circumferential groove mark on the hammer body or other fashioned mark is in alignment with the top edge of the guide tube (see Fig. A2.1). The guide tube shall have a circular base flange having a nominal outside diameter of 150 mm (5.9 in.), but no greater than will allow the guide tube flange to easily slip into the 152.4 mm (6.0 in.) mold used in Test Method D 698 Procedure C, Test Method D 1557 Procedure C or Test Method D 1883. The circular base flange is recessed on the underside so that it rests only around its perimeter.

A2.1.4 *Light Hammer (0.5 kg)*—The impact soil tester for the light hammer shall be similar in design to the device in Fig. 4 with the following modifications to the hammer (Fig. A2.2): The assembled hammer shall have a mass of between 0.50 kg (1.10 lbm) and 0.513 kg (1.13 lb) inclusive. The light hammer body shall be of solid cylindrical PVC plastic of a diameter of 50 mm \pm 0.2 mm (1.97 \pm 0.008 in.) with a planar and circular strike face. An accelerometer rated at a minimum of 5000 gravities is securely fastened to the top of the hammer body and preferably cover with a protective cap. The protective cap or other assembly shall have an electrical connector in place of the tubular handle in A2.1. The light hammer is raised by means of a coaxial cable attached to the electrical connector on the hammer. Include any strain relief fitting on the hammer as a part of the hammer mass. Do not include the coaxial cable and any strain relief cord as part of the hammer mass; however, it should be as light and short as practical. A cable length of around 1170 mm (3 ft. 10 in.) is suitable when using a hand held meter box. The height of drop, as measured from the underside of the strike face of the light hammer to the extreme

tubular handle, this is not considered as part of the mass but any strain relief fitting on the hammer is considered as part of the mass. If an electrical cable is used to connect the hammer's accelerometer to an external meter box or oscilloscope, this

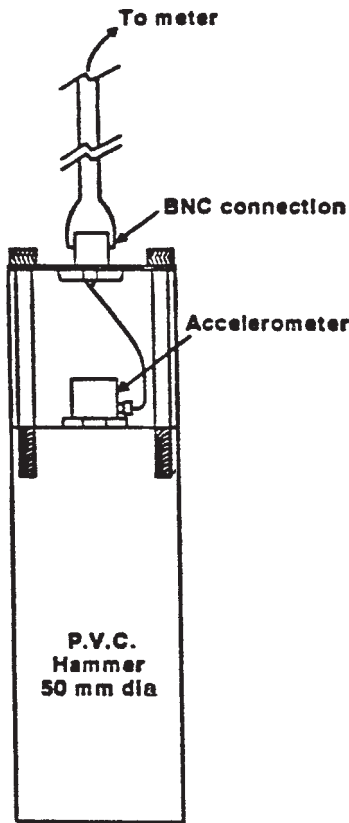

FIG. A2.2 Light Hammer

underside of the guide tube base when the light hammer is in the raised position, is between 300 mm (11.8 in.) and 305 mm (12 in.) inclusive. The correct height of drop may be set by a mark on the coaxial cable or hammer so that when the hammer is in the raised position, the lower edge of the mark is flush with the top of the guide tube, or instead by inserting a spacer with a hollow core for the coaxial cable to pass through in the top of the guide tube. A spacer and guide tube shall each be of a length and assembled in a manner that when the light hammer is drawn up to the spacer during operation, the hammer is at the set height of drop.

A3. Operational Check Ring

A3.1 Verify the correct operation of the 4.5 kg (10 lbm) impact soil tester using a polyurethane plastic check ring with the nominal dimensions of 50 mm (1.97 in.) OD, 30 mm (1.18 in.) ID, by 10 mm (0.39 in.) thick of a stiffness to give the meter a readout value in tens of gravities of around 30 with a ± 2 tolerance when the ring is placed on an appropriate surface and the hammer is dropped from the set height of drop onto the ring. A ring shall be marked with the correct operational check

valve and tolerance, both in tens of gravities, and the nominal hammer mass in kilograms. For the 0.5 kg (1.1 lbm) light hammer a ring of the same material type, stiffness and overall dimensions as the one described above, but with the cross-section thickness adjusted to provide values in tens of gravities of around 40 and marked accordingly is used to verify correct operation.

SUMMARY OF CHANGES

This section identifies the location of changes to this standard that have been incorporated since the 1995 edition that may impact the use of this standard.

- (1) Added Practice D 6026 caveat to Scope Section.
- (2) Added Test Methods D 4643, D 4959, and Practice D 6026 to Referenced Documents Section.
- (3) Added Test Methods D 4643, D 4959 to Section 9.1.3 for

- determining water content.
- (4) Editorial changes to comply with current ASTM form and style and D18 Procedures.
- (5) Added Summary of Changes Section.

 **D 5874 – 02**

ASTM International takes no position respecting the validity of any patent rights asserted in connection with any item mentioned in this standard. Users of this standard are expressly advised that determination of the validity of any such patent rights, and the risk of infringement of such rights, are entirely their own responsibility.

This standard is subject to revision at any time by the responsible technical committee and must be reviewed every five years and if not revised, either reapproved or withdrawn. Your comments are invited either for revision of this standard or for additional standards and should be addressed to ASTM International Headquarters. Your comments will receive careful consideration at a meeting of the responsible technical committee, which you may attend. If you feel that your comments have not received a fair hearing you should make your views known to the ASTM Committee on Standards, at the address shown below.

This standard is copyrighted by ASTM International, 100 Barr Harbor Drive, PO Box C700, West Conshohocken, PA 19428-2959, United States. Individual reprints (single or multiple copies) of this standard may be obtained by contacting ASTM at the above address or at 610-832-9585 (phone), 610-832-9555 (fax), or service@astm.org (e-mail); or through the ASTM website (www.astm.org).