



Standard Test Method for Evaluation of Engine Oils for Roller Follower Wear in Light-Duty Diesel Engine¹

This standard is issued under the fixed designation D 5966; the number immediately following the designation indicates the year of original adoption or, in the case of revision, the year of last revision. A number in parentheses indicates the year of last reapproval. A superscript epsilon (ε) indicates an editorial change since the last revision or reapproval.

INTRODUCTION

This test method is continually undergoing changes to reflect refinements in procedure, obsolescence of parts or reagents. These changes or updates, as well as general information regarding the test method, are issued as information letters by the ASTM Test Monitoring Center (TMC). Copies of information letters pertaining to the test method may be obtained by contacting the ASTM Test Monitoring Center.²

The test method can be used by any properly equipped laboratory, without assistance of anyone not associated with that laboratory. However, TMC provides reference oils and an assessment of the test results obtained on those oils by the laboratory. By this means, the laboratory will know whether their use of the test method gives results statistically similar to those obtained by other laboratories. Furthermore, various agencies require that a laboratory utilize the TMC services in seeking qualification of oils against specifications. For example, the U.S. Army imposes such a requirement, in connection with several military lubricant specifications.

Accordingly, this test method is written for use by laboratories which utilize the TMC services. Laboratories that choose not to use these services may simply ignore those portions of the test procedure which refer to the TMC.

1. Scope

1.1 This engine lubricant test method is commonly referred to as the Roller Follower Wear Test. Its primary result, roller follower shaft wear in the hydraulic valve lifter assembly, has been correlated with vehicles used in stop-and-go delivery service prior to 1993.³ It is one of the test methods required to evaluate lubricants intended to satisfy the API CG-4 performance category. This test has also been referred to as the 6.2 L Test.

1.2 The values of units used in this test method are stated in either inch-pound units or SI units and are to be regarded separately as the standard.

1.3 *This standard does not purport to address all of the safety concerns, if any, associated with its use. It is the responsibility of the user of this standard to establish appro-*

priate safety and health practices and determine the applicability of regulatory limitations prior to use.

1.4 Table of Contents:

	Section
Scope	1
Referenced Documents	2
Terminology	3
Summary of Test Method	4
Significance and Use	5
Reagents	7
Guidelines on Substitution	7.1
Apparatus	6
Preparation of Apparatus	8
New Engine Preparation	8.1
Installation of Auxiliary Systems	8.2
Test Procedure	9
Description of Test Segments and Organization	9.1
Engine Parts Replacement	9.2
Engine Starting Procedure	9.3
Normal Engine Shutdown Procedure	9.4
Emergency Shutdown Procedure	9.5
Unscheduled Shutdown and Downtime	9.6
New Engine Break-In	9.7
Pretest Procedure	9.8
Fifty-Hour Steady State Test	9.9
Periodic Measurements	9.10
Oil Sampling and Oil Addition Procedures	9.11
End of Test Procedure	9.12
Calculation and Interpretation of Test Results	10
Environment of Parts Measurement Area	10.1
Roller Follower Shaft Wear Measurements	10.2

¹ This test method is under the jurisdiction of ASTM Committee D02 on Petroleum Products and Lubricants and is the direct responsibility of Subcommittee D02.B0 on Automotive Lubricants.

Current edition approved Nov. 10, 2002. Published February 2003. Originally approved in 1996. Last previous edition approved in 1999 as D 5966-99.

² ASTM Test Monitoring Center, 6555 Penn Ave., Pittsburgh, PA 15206-4489. This edition incorporated revisions contained in all Information Letters through No. 01-1.

³ Supporting data have been filed at ASTM International Headquarters and may be obtained by requesting Research Report RR: D02-1218.

Oil Analysis	10.3
Assessment of Test Validity	10.4
Final Test Report	11
Reporting Calibration Test Results	11.1
Report Forms	11.2
Interim Non-Valid Calibration Test Summary	11.3
Severity Adjustments	11.4
Precision and Bias	12
Reference Oil Precision	12.1
Bias	12.3
Keywords	13
ANNEXES	
Guidelines for Test Part Substitution or Modifications	A1
Guidelines for Units and Specification Formats	A2
Detailed Specifications of Apparatus	A3
Calibration	A4
Final Report Forms	A5
Illustrations	A6
Kinematic Viscosity @ 100°C Procedure for Test Samples	A7
Enhanced Gravimetric Analysis TGA Procedure	A8
Sources of Materials and Information	A9
Roller Follower Wear Test (RFWT) Data Dictionary	A10
APPENDIXES	
Ranges for Howell LSRD-4 Reference Fuel	X1
Diagnostic Data Review	X2

2. Referenced Documents

2.1 ASTM Standards:

- D 86 Test Method for Distillation of Petroleum Products at Atmospheric Pressure⁴
- D 92 Test Method for Flash and Fire Points by Cleveland Open Cup⁴
- D 97 Test Method for Pour Point of Petroleum Products⁴
- D 130 Test Method for Detection of Copper Corrosion from Petroleum Products by the Copper Strip Tarnish Test⁴
- D 235 Specification for Mineral Spirits (Petroleum Spirits) (Hydrocarbon Dry Cleaning Solvent)⁵
- D 287 Test Method for API Gravity of Crude Petroleum and Petroleum Products (Hydrometer Method)⁴
- D 445 Test Method for Kinematic Viscosity of Transparent and Opaque Liquids (the Calculation of Dynamic Viscosity)⁴
- D 446 Specifications and Operating Instructions for Glass Capillary Kinematic Viscometer⁴
- D 482 Test Method for Ash from Petroleum Products⁴
- D 524 Test Method for Ramsbottom Carbon Residue of Petroleum Products⁴
- D 613 Test Method for Cetane Number of Diesel Fuel Oil⁶
- D 1319 Test Method for Hydrocarbon Types in Liquid Petroleum Products by Fluorescent Indicator Adsorption⁴
- D 2500 Test Method for Cloud Point of Petroleum Products⁴
- D 2622 Test Method for Sulfur in Petroleum Products by Wavelength Dispersive X-Ray Fluorescence Spectrometry⁴
- D 2709 Test Method for Water and Sediment in Middle Distillate Fuels by Centrifuge⁴
- D 4175 Terminology Relating to Petroleum, Petroleum Products, and Lubricants⁷
- D 4485 Specification for Performance of Engine Oils⁷

- D 4737 Test Method for Calculated Cetane Index by Four Variable Equation⁷
- D 5185 Test Method for Determination of Additive Elements, Wear Metals, and Contaminants in Used Lubricating Oils and Determination of Selected Elements in Base Oils by Inductively Coupled Plasma Atomic Emission Spectrometry⁷
- D 5186 Test Method for Determination of Aromatic Content of Diesel Fuels and Aviation Turbine Fuels by Supercritical Fluid Chromatography⁷
- D 5302 Test Method for Evaluation of Automotive Engine Oils for Inhibition of Deposit Formation and Wear in a Spark-Ignition Internal Combustion Engine Fueled with Gasoline and Operated Under Low-Temperature, Light-Duty Conditions⁷
- D 5844 Test Method for Evaluation of Automotive Engine Oils for Inhibition of Rusting (Sequence IID)⁸
- E 29 Practice for Using Significant Digits in Test Data to Determine Conformance With Specifications⁹
- E 344 Terminology Relating to Thermometry and Hydrometry¹⁰
- 2.2 *Society of Automotive Engineers (SAE)*:¹¹
 - SAE J183 Engine Oil Performance and Engine Service Classification
 - SAE J726 Air Cleaner Test Code (Includes Piezometer Ring Specifications)
- 2.3 *American Petroleum Institute (API)*:¹²
 - API 1509 Oil Licensing and Certification System
- 2.4 *American National Standards Institute (ANSI)*:¹³
 - MC96.1 Temperature Measurement Thermocouples

3. Terminology

3.1 Definitions:

- 3.1.1 *blowby, n*—in internal combustion engines, the combustion products and unburned air-and-fuel mixture that enter the crankcase. **D 5302**
- 3.1.2 *BTDC, adj*—abbreviation for Before Top Dead Center, used with the degree symbol to indicate the angular position of the crankshaft relative to its position at the point of uppermost travel of the piston in the cylinder.
- 3.1.3 *calibrate, v*—to determine the indication or output of a measuring device with respect to that of a standard. **E 344**
- 3.1.4 *candidate oil, n*—an oil which is intended to have the performance characteristics necessary to satisfy a specification and is tested against that specification. **D 5844**
- 3.1.5 *engine oil, n*—a liquid that reduces friction or wear, or both, between the moving parts within an engine; removes heat, particularly from the underside of pistons; and serves as a combustion gas sealant for piston rings.

⁸ Annual Book of ASTM Standards, Vol 05.03.

⁹ Annual Book of ASTM Standards, Vol 14.02.

¹⁰ Annual Book of ASTM Standards, Vol 14.03.

¹¹ These standards available only in SAE Handbook, Vol 3 or SAE Fuels and Lubricants Standards Manual HS23 from Society of Automotive Engineers, Inc., 400 Commonwealth Dr., Warrendale, PA 15096-0001.

¹² Available from American Petroleum Institute, 1220 L Street NW, Washington, DC 12005-4018.

¹³ Available from American National Standards Institute (ANSI), 25 W. 43rd St., 4th Floor, New York, NY 10036.

⁴ Annual Book of ASTM Standards, Vol 05.01.

⁵ Annual Book of ASTM Standards, Vol 06.04.

⁶ Annual Book of ASTM Standards, Vol 05.04.

⁷ Annual Book of ASTM Standards, Vol 05.02.

3.1.5.1 *Discussion*—It may contain additives to enhance certain properties. Inhibition of engine rusting, deposit formation, valve train wear, oil oxidation and foaming are examples.

Subcommittee B Glossary¹⁴

3.1.6 *light-duty, adj*— in internal combustion engine operation, characterized by average speeds, power output, and internal temperatures that are generally much lower than the potential maximums. **D 4485**

3.1.7 *light-duty engine, n*— in internal combustion engine types, one that is designed to be normally operated at substantially less than its peak output. **D 4485**

3.1.8 *lubricant, n*—any material interposed between two surfaces that reduces friction or wear, or both, between them.

Subcommittee B Glossary¹⁴

3.1.9 *lubricating oil, n*—a liquid lubricant, usually comprising several ingredients, including a major portion of base oil and minor portions of various additives.

Subcommittee B Glossary¹⁴

3.1.10 *reference oil, n*—an oil of known performance characteristics, used as a basis for comparison.

3.1.10.1 *Discussion*—Reference oils are used to calibrate testing facilities, to compare the performance of other oils, or to evaluate other materials (such as seals) that interact with oils. **D 5844**

3.1.11 *used oil, n*—any oil that has been in a piece of equipment (for example, an engine, gearbox, transformer, or turbine), whether operated or not. **D 4175**

3.1.12 *wear, n*—the loss of material from, or reduction of material on, a surface.

3.1.12.1 *Discussion*—Wear generally occurs between two surfaces moving relative to each other, and is the result of mechanical or chemical action or a combination of both. **D 5302**

4. Summary of Test Method

4.1 A pre-assembled GM V8 diesel test engine is installed on a test stand and operated for 50 h.

4.2 The test engine operating conditions are generally more extreme than typical service operating conditions. These conditions provide high soot loading and accelerated roller follower shaft wear while maintaining correlation with wear levels found in the field.³

4.3 At the end of the test, the performance of the engine oil is determined by measuring the level of wear on the roller follower shafts.

5. Significance and Use

5.1 This test method is used to determine the ability of an engine crankcase oil to control wear that can develop in the field under low to moderate engine speeds and heavy engine loads. Side-by-side comparisons of two or more oils in delivery van fleets were used to demonstrate the field performance of various oils.³ The specific operating conditions of this test method were developed to provide correlation with the field performance of these oils.

5.2 This test method, along with other test methods, defines the minimum performance level of the Category API CG-4 for heavy duty diesel engine lubricants. Passing limits for this category are included in Specification D 4485.

5.3 The design of the engine used in this test method is not representative of all modern diesel engines. This factor, along with the specific operating conditions used to accelerate wear, shall be considered when extrapolating test results.

6. Apparatus

6.1 A listing and complete description of all apparatus used in the test is found in Annex A3. Information concerning procurement of apparatus can be found in Appendix X1.

7. Reagents

7.1 *Guidelines on Substitution*—No substitutions for the reagents listed in 7.1.1-7.1.3 are allowed.

7.1.1 *Aliphatic Naphtha*, acceptable from any supplier. (**Warning**—Flammable. Health hazard. Use adequate safety provisions with all solvents and cleansers.)

7.1.2 *Engine Coolant*—The engine coolant is a solution of demineralized water which has less than 0.03 g/kg dissolved solids and an ethylene glycol based anti-freeze mixed at the following concentration—70 % antifreeze and 30 % water by volume.

7.1.2.1 *Demineralized Water*, is used as a generic term to describe *pure* water. Deionized or distilled water may also be used as long as the total dissolved solids content is less than 0.03 g/kg.

7.1.3 *Fuel*—Approximately 600 L of Howell LSRD-4 reference diesel fuel are required for each test.¹⁵ (**Warning**—Combustible. Health hazard. Use adequate safety provisions.)

7.1.3.1 *Fuel Batch Analysis*—Each fuel shipment does not need to be analyzed upon receipt from the supplier. However, laboratories are responsible for periodic checks for contamination. Any analysis results for parameters tested should be within the tolerances shown on Fig. A5.20. If any results fall outside the tolerances shown on Fig. A5.20, the laboratory should contact the Test Monitoring Center (TMC)² for help in resolving the problem.

7.1.3.2 *Fuel Batch Storage*—The fuel should be stored in accordance with all applicable safety and environmental regulations.

7.1.4 *Break-In Oil*—Approximately 8 kg of break-in oil are necessary for new engine break-in. Break-in oil is defined as any SAE 15W-40, API CG-4 quality oil.

7.1.5 *Non-Reference Test Oil*—A minimum of 20 kg of new oil are required to complete the test. A 25-kg sample of new oil is normally provided to allow for inadvertent losses.

7.1.6 *Calibration Test Oil*—A 22-kg sample of reference oil is provided by the TMC for each calibration test.

8. Preparation of Apparatus

8.1 *New Engine Preparation*—Paragraphs 8.1.1 through 8.1.8 describe preparations that are only performed on a new engine before conducting the new engine break-in.

¹⁴ Available from Mr. J. L. Newcombe, Exxon Chemical Co., 26777 Central Park Blvd., Ste 300, Southfield, MI 48076.

¹⁵ Available from Howell Hydrocarbon Inc., Ten Lamar, Ste 1800, Houston, TX 77002.

8.1.1 *Engine Front Cover Installation*— Install the front cover to the front of the engine block with the gasket supplied and torque all bolts to 40 N·m.

8.1.2 *Oil Sump Drain Location*—Install a drain in the sump as described in A3.9.3.7.

8.1.3 *Glow Plug Replacement*—Remove the glow plugs and install 27-in. dry seal NPT socket pressure plugs. Torque the plugs to 20 N·m.

8.1.4 *Cold Start Solenoid Disablement*— Disconnect the cold start solenoid.

8.1.5 *Exhaust Manifolds*—Check the flanges to ensure the gasket surfaces are not distorted. Install the required water-cooled exhaust manifolds with the discharge toward the rear of the engine. Use the special studs supplied with the manifolds, and torque the studs to 30 N·m.

8.1.6 *Rocker Arm Cover Preparation*—Install a new seal to each rocker arm cover lid. Install a new gasket on each rocker arm cover mounting flange. Install the rocker arm covers, but not the lids, at this time.

NOTE 1—The rocker arm cover lid is removed after each test. An adhesive material can be used to adhere the gasket to the rocker arm cover lid. Installation of a small amount of petroleum jelly to the sealing surface facilitates removal and extends the life of the seal.

8.1.7 *Injection Pump Position Verification*—Verify the dynamic timing marks on the engine and injection pump flanges are properly aligned. The mark is a line scribed across the top of the pump mounting flange and the injection pump gear drive cover flange.

8.2 *Installation of Auxiliary Systems and Miscellaneous Components:*

8.2.1 *Exhaust Back Pressure Transducer Lines*—Check the lines leading to the pressure transducer. Remove any obstructions in the lines.

8.2.2 *Crankcase Ventilation System*—Clean the oil separator. Install the crankcase vent tube to the atmosphere by way of the oil separator on the rear of the right rocker arm cover as shown in Fig. A3.3.

8.2.3 *External Oil System Installation*— Configure the external oil system according to the schematic diagram shown in Fig. A3.2. Ensure all hoses and fittings on the oil heat exchanger are properly connected and secure.

8.2.3.1 Brass and copper fittings may influence used oil wear metals analyses and shall not be used in the external oil system.

8.2.4 *Engine Cooling System Installation*— A suggested engine cooling system is shown in Fig. A3.4.

8.2.4.1 Remove the thermostat.

8.2.5 *Engine Coolant System Charge*—Charge the engine with coolant solution mixed to the concentration shown in 7.1.2.

8.2.6 *Intake Air System Installation*— Install the intake air horn and Piezometer ring.

8.2.7 *Exhaust System Installation*—Install the exhaust manifolds and the exhaust manifold discharge flanges.

9. Test Procedure

9.1 *Description of Test Segments and Organization of Test Procedure Sections:*

9.1.1 *New Engine Break-in*—A break-in is only performed on a new engine. A break-in is not performed before each steady state test. New engine break-in is detailed in 9.7.

9.1.2 *Pretest Procedure*—The pretest segment is used to flush previous oil from the test engine and is performed before each 50-h wear test. Pretest segment is detailed in 9.8.

9.1.3 *Fifty-Hour Steady State Test*—The actual test used to measure roller follower shaft wear is a 50-h test run at steady state conditions shown in Table 1. Paragraph 9.9 describes the operation of the 50-h test.

9.1.4 *Engine Starting and Shutdown Procedures*— Paragraphs 9.3-9.5 describe the engine starting and shutdown procedures.

9.2 *Engine Parts Replacement*—The roller followers cannot be replaced during the test. Record the circumstances involved in any other engine parts replacement on the Supplemental Operational Data pages.

9.3 *Engine Starting Procedure*—The following procedure shall be used each time the engine is started:

9.3.1 Turn on the safety circuits and the engine coolant pump.

9.3.2 Crank the engine.

9.3.3 The control systems shall allow the engine to start within 10 s. (**Warning**—Verify that the oil sump and cooling system have been charged before starting the engine.) (**Warning**—Verify there is an adequate supply of cooling water to the exhaust manifolds and external heat exchangers. Without sufficient coolant flow, the engine and exhaust manifolds will overheat and sustain serious damage.) (**Warning**—Do not spray starting fluids into the intake-air horn to assist engine starting.) (**Warning**—Do not crank the engine excessively. If starting difficulties are encountered, perform diagnostics to determine why engine will not start. Excessive cranking times may promote increased engine wear.)

9.3.4 Operate the engine speed at 1000 r/min and no load 5 min.

9.3.5 After 5 min, increase the load to 7.5 kW and maintain the engine speed at 1000 r/min. Maintain this condition for 15 min. The test time begins 10 min after the completion of the 15 min warm-up period.

TABLE 1 Steady State Operating Conditions

Parameter	Specification
Speed, r/min	1000 ± 5
Torque, N·m	Record
Power, kW	Record (target range, 30–34 kW)
Fuel rate, kg/h (6.2 L engine)	9.00 ± 0.10
Fuel rate, kg/h (6.5 L engine)	9.40 ± 0.10
Fuel temperature, °C	35.0 ± 2.0
Coolant inlet temperature, °C	Record
Coolant outlet temperature, °C	120.0 ± 2.0
Coolant flow rate, L/min	Record (target range, 53–61 L/min)
Coolant pressure, kPa	Record (target range, 93–107 kPa)
Main oil gallery temperature, °C	120.0 ± 2.0
Intake air temperature, °C	32.0 ± 2.0
Exhaust temperature, °C	Record
Oil sump temperature, °C	Record
Intake air pressure, kPa	97.0 ± 1.0
Crankcase pressure, kPa	Record
Exhaust back pressure, kPa	103.0 ± 1.0

9.3.6 During the 10 min after the warm-up, maintain the engine speed at 1000 r/min and increase the load until the fuel consumption rate meets the specification shown in Table 1. Maintain these conditions for the duration of the test.

9.4 *Normal Engine Shutdown Procedure*— Unless an emergency condition exists, the following procedure shall be followed each time the engine is shutdown.

- 9.4.1 Reduce the engine load to 0 kW.
- 9.4.2 Operate the engine for 5 min.
- 9.4.3 Stop the engine.

9.5 *Emergency Shutdown Procedure*—If an emergency condition exists, shut off the fuel supply and stop the engine.

9.6 *Unscheduled Shutdowns and Downtime*— The test can be shut down at any convenient time to perform unscheduled maintenance. Report all unscheduled shutdowns on Fig. A5.19 of the final test report.

9.6.1 *Resumption of Test Time After a Shutdown*—After a shutdown, test time begins 10 min after the completion of the 15 min period at 7.5 kW in 9.3.5.

9.7 *New Engine Break-in*—The break-in provides an opportunity to stabilize a new engine and is only performed after a new engine has been installed on the test stand and prior to a reference test. The break-in is not performed before each 50-h non-reference test.

9.7.1 The break-in is comprised of two stages—a stepped, steady state stage and a cyclic stage. Table 2 describes the steady state stage. The cyclic portion is described in Table 3 (see 9.7.3.3 and 9.7.3.4).

9.7.1.1 Use the lifters which came in the assembled engine for the engine break-in.

- 9.7.2 *New Engine Break-in Oil Charge:*
- 9.7.2.1 Install a new AC PF-35 oil filter.
- 9.7.2.2 Connect the flush system outlet to the oil cooler.
- 9.7.2.3 Use the flush system to charge 6.5 kg of break-in oil into the engine.

NOTE 2—Break-in oil is defined in 7.1.5.

9.7.2.4 Remove the flush system outlet hose from the oil cooler and cap the oil cooler fitting.

9.7.3 *New Engine Break-in Operating Procedure:*

9.7.3.1 Start the engine according to 9.3.

9.7.3.2 Operate the engine according to the steady state sequence shown in Table 2.

9.7.3.3 Operate the engine according to the cyclic sequence shown in Table 3. Except for speed and load, use the targets shown in Table 4 for all other controller set points. Total cycle length is 30 min (a cycle includes Steps 2 through 17). Each transition is 30 s in length. Steps 2 through 11 are 60 s each; Steps 12 through 17 are 120 s each. Repeat the cycle 100 times to complete the 50-h cyclic portion of the break-in.

TABLE 2 Break-in Sequence, Steady State Stage^A

Step	Engine Speed, r/min	Engine Load, N-m	Time, min
1	1000	120	30
2	2000	140	30
3	3000	180	30
4	3600	200	30
5	3800	0	30
6	3000	full power	30

^ASee Table 4 for remaining steady state break-in specifications.

TABLE 3 Break-in Sequence, Cyclic Stage

Step	Engine Speed, r/min	Engine Load, N-m	Stage Length, min
1	650	idle	
2	max. governed (3800)	no load	1
3	3600	full (310)	1
4	2800	full (350)	1
5	2000	full (370)	1
6	1450	220	1
7	max. governed (3800)	no load	1
8	3600	full (310)	1
9	2800	full (350)	1
10	2000	full (370)	1
11	1450	220	1
12	max. governed (3800)	no load	2
13	3600	full (310)	2
14	2800	full (350)	2
15	2000	full (370)	2
16	1450	220	2
17	650	idle	2

TABLE 4 Break-in Operating Targets, Steady State and Cyclic Stages^A

Controlled Parameter	Specification
Engine speed, r/min	see Tables 1 and 2
Torque, N-m	see Tables 1 and 2
Power, kW	Record
Fuel temperature, °C	35 ± 2
Coolant inlet temperature, °C	Record
Coolant outlet temperature, °C	120 ± 2
Coolant flow rate, L/min	190 ± 8
Coolant pressure, kPa	100 ± 7
Main oil gallery pressure, kPa	Record
Main oil gallery temperature, °C	120 ± 2
Intake air temperature, °C	32 ± 2
Exhaust temperature, °C	Record
Oil sump temperature, °C	Record

^AThe retention of break-in data is at the discretion of the laboratory.

9.7.3.4 The engine will not maintain specifications for some of the parameters shown in Table 4 especially during the cyclic stage. Controller set points should be maintained at the specifications shown in Table 4 for all parameters except engine speed and load.

9.7.3.5 The engine will consume oil during the cyclic portion of the break-in. An engine will normally consume 1 L of oil/16 h of break-in operation. Approximately 1 L of oil should be added during Step 17 at 17 h and 34 h.

9.8 *Pretest Procedure*—The engine pretest procedure allows an opportunity to charge the crankcase with test oil, verify injection timing, check the crankcase dipstick level and install test lifters (roller followers). Complete the pretest procedure before running each 50-h steady state reference or non-reference test.

9.8.1 The laboratory ambient atmosphere shall be reasonably free of contaminants. Temperature and humidity level of the operating area are not specified. Divert air from fans or ventilation systems away from the test engine.

9.8.2 *Initial Test Oil Flush and Lifter Installation:*

- 9.8.2.1 Weigh and install a new AC PF-35 oil filter.
- 9.8.2.2 Connect the flush system inlet to the fitting on the bottom of the oil pan.
- 9.8.2.3 Connect the flush system outlet to the external oil cooler inlet.

9.8.2.4 Charge 6.0 kg of test oil into the engine. Record the actual weight of the oil charge.

9.8.2.5 Circulate the oil with the flush system for 15 min.

9.8.2.6 Drain and weigh the oil from the engine. Remove, weigh, and discard the oil filter.

9.8.2.7 Install a new set of hydraulic lifters in the engine position noted on the roller follower shaft. Orient the hydraulic lifters so that the oil hole faces the front of the engine.

NOTE 3—A description of the markings on the end of the roller follower shafts is shown in Fig. A6.1.

NOTE 4—A map of hydraulic lifter positions in the engine is shown in Fig. A3.4.

9.8.2.8 Install the hydraulic lifter guide and hold down plates. Torque the hold down plates to 35 N·m.

9.8.2.9 Install the push rods and rocker arm assemblies in the engine locations marked on the parts. Torque the rocker arm shafts to 50 N·m. Refer to the GM Diesel Engine service manual (GM 16015.05-2) for proper installation.

9.8.3 *Second Test Oil Flush:*

9.8.3.1 Weigh and install a new test oil filter.

9.8.3.2 Charge 6.0 kg of test oil into the engine by way of the flush system. Record the actual weight of the oil charge.

9.8.3.3 Install the rocker arm cover lids.

9.8.3.4 Circulate the oil with the flush cart for 15 min.

9.8.3.5 After the oil has circulated for 5 min, crank the engine for a minimum of 2 min. Leave the flush system on while the engine is cranked.

9.8.3.6 Drain and weigh the oil from the engine. Remove, weigh, and discard the oil filter.

9.8.4 *Test Oil Charge:*

9.8.4.1 Weigh and install new oil filter.

9.8.4.2 Disconnect the flush system inlet hose from the oil pan. Install the cap on the oil pan fitting.

9.8.4.3 Use the flush system to charge 6.0 kg of test oil into the engine. Turn off the flush system before the inlet hose picks up air.

9.8.4.4 Remove the flush system outlet hose from the oil cooler. Install the cap on the oil cooler fitting. Be careful not to lose any portion of the test oil charge.

9.8.4.5 Purge the flush system into a container and pour all purged oil into the engine.

9.8.4.6 After a minimum of 2 min, check the oil level with the dipstick. The oil level should be at or near the full mark.

9.8.5 *Installation of the Crankcase Pressure Transducer*—Remove the dipstick and install the line leading to the crankcase pressure transducer to the dipstick tube.

9.8.6 *Calibration of the TDC Indicator*—Verifying the calibration of the TDC indicator located on the harmonic balancer is recommended.

9.8.7 *Verification of Injection Timing*—Start the engine according to 9.3. After the engine speed and fuel rate have stabilized at the specifications shown in Table 1, verify the injection timing is 11.5 ± 0.5 using the default settings on the timing meter. If the injection timing is outside this specification, rotate the injection pump and remeasure the timing.

9.9 *Fifty-Hour Steady State Test*—Start the engine according to 9.3. Operate the engine for 50 h at the steady state conditions noted in Table 1.

9.10 *Periodic Measurements:*

9.10.1 *Operational Data Acquisition*—Record the operational parameters shown in Table 1 (with the exception of coolant flow rate and coolant pressure) with automated data acquisition at a minimum frequency of once every 6 min.

9.10.2 *Injection Timing Measurement*—Measure and record the injection timing at least once every test.

9.11 *Oil Sampling and Oil Addition Procedures*—Take used oil samples at 25 and 50 h and add oil at 25 h. Make no other new oil additions or samples during the test. The sampling and new oil addition procedures are detailed below.

9.11.1 *Twenty-Five-Hour Oil Sampling and Oil Addition Procedure:*

NOTE 5—The engine is not shut down for oil addition or oil sampling at 25 h.

9.11.1.1 Weigh 1.0 kg of new oil into a beaker.

9.11.1.2 Remove a 100 mL purge from the engine. Then remove a 100 mL analysis sample from the engine. Label the sample bottle for identification with the test number, date, test hour, and oil code.

9.11.1.3 Pour the 1.0 kg of new test oil and the 100 mL purge into the engine.

9.11.2 *Fifty-Hour Oil Sampling Procedure:*

NOTE 6—The engine is not shut down for oil sampling at 50 h.

9.11.2.1 Remove a 100 mL purge from the engine. Remove a 100 mL analysis sample from the engine. Label the sample bottle for identification with the test number, date, test hour, and oil code.

9.12 *End of Test (EOT) Procedure:*

9.12.1 *Engine Oil Removal*—Drain the oil from the sump within 60 min of EOT.

9.12.2 *Solvent Flush:*

9.12.2.1 Charge approximately 7 L of aliphatic naphtha into the engine by way of the flush system.

9.12.2.2 Circulate the solvent with the flush system for 20 min. While the solvent is circulating through the engine, rotate the engine two complete revolutions by hand to flush the valve train assembly.

9.12.2.3 Disconnect the flush system, and drain the solvent from the engine. If the engine is going to be laid up, flush and drain the engine with a 15W40 API CG-4 quality oil to prevent rusting.

9.12.3 *Lifter Removal*—Remove the lids from the rocker arm covers and remove the lifters from the engine.

9.12.4 *Roller Follower Shaft Removal*—Remove the axle from the lifter body by pressing the shaft from the body.

10. Calculation and Interpretation of Test Results

10.1 *Environment of Parts Measurement Area*—The ambient atmosphere of the parts measurement area shall be reasonably free of contaminants. Maintain the temperature within $\pm 3.0^\circ\text{C}$ of the temperature of the area when the machines were calibrated.

10.2 *Roller Follower Shaft Wear Measurements*—Measure and record the shape of the wear scar using a skidless stylus type measuring device. Make the measurement with the reference line etched on the end of the roller follower shaft in

a vertical position in the measuring device. Calculate the wear from the wear trace chart. In this test, wear for a given shaft is defined as the maximum vertical depth shown on the wear trace chart. An example of a typical wear trace and wear determination is shown in Fig. A6.2. Record the calculated wear and corresponding lifter position number.

10.3 Oil Analysis:

10.3.1 Wear Metals—Measure Al, Cr, Cu, Fe, Pb, Si, and Sn content on oil samples at 0 h (new oil from container), 25 h and 50 h. Test Method D 5185 is recommended.

10.3.2 Viscosity—Measure kinematic viscosity at 100°C on oil samples from 0 h (new oil), 25 h and 50 h in accordance with Annex A7.

10.3.3 Soot Quantity—Determine the soot quantity, % mass, on oil samples from 0 h (new oil), 25 h and 50 h in accordance with Annex A8.

10.4 Assessment of Test Validity—Specific requirements to determine test validity status are shown in Table 5. The testing laboratory shall use engineering judgment to assess the validity of tests which have deviations from the items listed in Table 5. The TMC will assist the laboratory in the determination of test validity, if requested by the laboratory. The mean of each parameter listed below, except injection timing, shall fall within the ranges listed below.

10.5 Injection timing is only measured once per test. All other parameters are measured at least once per 6 min.

10.6 All instrumentation shall be calibrated in accordance with Table A4.1.

11. Final Test Report

11.1 Reporting Calibration Test Results— Report all calibration (reference oil) tests to the TMC within five days of test completion. Facsimile transmit Fig. A5.1, Fig. A5.2, Fig. A5.3, Fig. A5.17, and Fig. A5.19 (reference Annex A5) to the ASTM TMC.² A copy of the final test report (all forms) should be submitted by mail to the test developer and the TMC within 30 days of test completion (reference A9.1).

11.2 Report Forms—The final report forms are shown in Annex A5. These forms are to be used for both calibration and non-reference tests. Use the Data Dictionary formats as shown in Annex A5 to report test values.

11.2.1 Electronic Data Transmission of Test Results—Annex A5 contains the RFWT and Header Data dictionaries. Additional information is also provided for its use. This information is provided to anyone wishing to transmit test information electronically. For more information on electronic transmissions, contact the TMC.

11.3 Interim Non-Valid Calibration Test Summary—This information includes test run number, test start and completion dates, the blind oil code, the industry oil code, the reason the test was not acceptable, the corrective action, and any other pertinent information. Include this information in the comments section of Fig. A5.19. Include a comment for each non-valid or aborted calibration test in a series.

11.4 Severity Adjustments—This test incorporates the use of a Severity Adjustment (SA) for non-reference test results. A control chart technique, described in 11.4.1 and 11.4.2, has been selected for the purpose of identifying when a bias becomes significant for Roller Follower Shaft Wear. When a significant bias is identified, a SA is applied to non-reference test results. The SA remains in effect until subsequent calibration test results indicate that the bias is no longer significant. SAs are calculated and applied on a laboratory basis.

11.4.1 Control Chart Technique For Severity Adjustments (SA)—Standardized calibration test results are applied using an exponentially weighted moving average (EWMA) technique. Values are standardized to Δ/s (result—target)/standard deviation). The targets and standard deviations for current calibration oils are published by the ASTM TMC. Include all operationally valid calibration tests in a laboratory control chart. Chart tests in order of completion. Record completion of tests by EOT date and time. EOT time is reported as hour and minute (Central Time) according to the 24-h clock (1 am = 1:00, 1 pm = 13:00). Reporting test completion time enables the TMC to properly order tests that are completed on the same day for industry plotting purposes. Report calibration tests to the TMC in order of test completion. A minimum of two tests is required to initialize a control chart.

11.4.2 Calculate EWMA values using the following equation:

$$Z_i = 0.2(Y_i) + 0.8(Z_{i-1}) \tag{1}$$

where:

$Z_0 = 0$,

$Y_i =$ standardized test result, and

$Z =$ EWMA of the standardized test result at test order i .

If the absolute value of EWMA, rounded to three places after the decimal, exceeds 0.600 then apply an SA to subsequent non-reference results.

11.4.3 Calculation of Severity Adjustment—The following example illustrates how to compute and apply EWMA and SA values. Please note, that test targets are presented for examples only.

Roller Follower Shaft Wear SA

TMC Oil 1004

Applicable Test Targets:

Mean = 0.41

Standard Deviation = 0.07

$Z_1 = -0.400$

TABLE 5 Operational Validity Requirements

Parameter	Specification
Speed, r/min	1000±5
Fuel rate, kg/h (6.2 L engine)	9.0±0.10
Fuel rate, kg/h (6.5 L engine)	9.40±0.10
Fuel temperature, °C	35.0±2.0
Coolant outlet temperature, °C	120.0±2.0
Main oil gallery temperature, °C	120.0±2.0
Intake air temperature, °C	32.0±2.0
Intake air pressure, kPa	97.0±1.0
Exhaust back pressure, kPa	103.0±1.0
Injection timing, °BTDC	11.5±0.5

Test Result:

$$T_2 = 0.30$$

Standard Test Result:

$$Y_2 = (T_2 - \text{Mean})/\text{Standard Deviation} = -1.571$$

$$\text{EWMA: } Z_2 = 0.2(Y_2) + 0.8(Z_1) = -0.634$$

11.4.3.1 Since $|-0.634| > 0.600$, apply an SA: SA = (-1) (EWMA) (standard deviation). Round this result to two decimal places. Enter this number on Fig. A5.2 under the non-reference oil test block in the space for severity adjustment. Add this value to non-reference average wear results. Enter the adjusted wear value in the appropriate space. An SA will remain in effect until the next calibration test. At that time, calculate a new EWMA.

12. Precision and Bias

12.1 *Reference Oil Precision and Reproducibility*—The TMC determines estimates of precision from calibration test results. These precision data are periodically updated and are available from the TMC.

12.2 Table 6 below shows the precision data (repeatability and reproducibility) for the Roller Follower Wear Test. Data was obtained from April 1993 through April 1995.

12.3 *Bias*—Bias is determined by applying an accepted statistical technique to reference oil test results and when a significant bias is determined, a severity adjustment is permitted for non-reference oil test results (see 11.4).

13. Keywords

13.1 calibrate; diesel engine; engine oil; light-duty; light-duty engine; lubricant; reference oil; roller follower shaft wear; used oil wear

TABLE 6 Test Precision—Reference Oils 1004 and 1004-1

Parameter	No. of Labs	N	Repeatability (<i>r</i>)	Reproducibility (<i>R</i>)
Roller follower wear	5	33	0.17	0.18

ANNEXES

(Mandatory Information)

A1. GUIDELINES FOR TEST PART SUBSTITUTION OR MODIFICATION

A1.1 *Engine Component Modifications*—No modifications are allowed to bring any engine component within a specification or cause a part to operate within a specification.

A1.2 *Test Part Substitution*—Obtain all lifters and engines used from the supplier listed in Appendix X1. Obtain oil filters used in the 50-h, steady state portion of the test from the

supplier listed in Appendix X1.

A1.3 *Substitution or Modification of Auxiliary Test Stand Equipment*—Substitutions or modifications of auxiliary test stand equipment are only allowed where explicitly stated or if the word *suggested* is used to describe a modification or component.

A2. GUIDELINES FOR UNITS AND SPECIFICATION FORMATS

A2.1 *Specified Units*—All dimensions are specified in appropriate SI units except pipe fittings, thermocouple diameters, and roller follower shaft wear. Pipe fittings and thermocouples are available worldwide and are not interchangeable with SI sized equivalents because of differences in thread dimensions. Since they are not interchangeable, no SI conversion is stated.

A2.2 *Significant Digits*—The appropriate number of significant digits for each operational parameter is shown in Table A2.1 (also refer to the Data Dictionary in Annex A10). Report operational data and wear measurement using the number of significant digits specified in Table A2.1.

A2.2.1 The following information applies to all specified limits in this standard. For purposes of determining conformance with these specifications, an observed value or a calculated value shall be rounded off to the nearest unit in the last

right hand figure used in expressing the limiting value in Table A2.1. This is in accordance with the rounding-off method of Practice E 29.

A2.3 *Units for Measurements and Unit Conversions*—With the exceptions noted in A2.1, all dimensions have been specified with rounded, convenient metric values where possible. The intent of this procedure is to cause all measurements to be completed directly in appropriate metric units. Because many specifications will not round to convenient inch-pound values, application of calibration and measurement systems that use metric units is strongly recommended. If the laboratory chooses to measure parameters in inch-pound units, the laboratory may be required to demonstrate that such measurements are within the appropriate tolerances specified in metric units after conversion to metric units.

A2.3.1 If the laboratory measures a parameter in inch-pound units, two conversions will be required before reporting:

TABLE A2.1 Significant Digits for Operating Conditions

Parameter	Round off to Nearest
Speed	1 r/min
Torque	1 N·m
Power	0.1 kW
Fuel rate	0.01 kg/h
Fuel temperature	0.1°C
Coolant inlet temperature	0.1°C
Coolant outlet temperature	0.1°C
Coolant flow rate	1 L/min
Coolant pressure	1 kPa
Main oil gallery temperature	0.1°C
Intake air temperature	0.1°C
Exhaust temperature	0.1°C
Oil sump temperature	0.1°C
Intake air pressure	0.1 kPa
Crankcase pressure	0.01 kPa
Exhaust back pressure	0.1 kPa
Injection timing	0.1°BTDC

Significant Digits for Wear Results	
Parameter	Round off to nearest
Roller follower shaft wear	0.00001 in.

one for conversion to inch-pound units for measurement and another conversion back to metric units for reporting. Inappropriate conversions or tolerance stacking could cause significant error.

A3. DETAILED SPECIFICATIONS OF THE APPARATUS

A3.1 The test engine is based on the General Motor Corporation's V8 indirect injection diesel engine. Assemble the test engine using modified cylinder heads and an individually timed injection pump.

A3.2 Use an engine test stand equipped to control engine speed and load, and various temperatures, pressures, and flow rates.

A3.3 Use an automated data acquisition system to measure various operating parameters.

A3.4 Use external systems to control engine intake air, fuel, coolant, and oil temperatures and pressures.

A3.5 Various external apparatus are required to measure and calibrate engine components, control systems, and operating parameters.

A3.6 *Organization of Apparatus Description Sections*—Detailed description of the apparatus is grouped into the following sections:

A3.6.1 *The Test Engine*— Paragraph A3.7.

A3.6.2 *Control Systems*— Paragraph A3.8.

A3.6.3 *Measurement Transducers and Systems*—Paragraph A3.9.

A3.7 *Test Engine:*

A3.7.1 *Test Engine Kit*—Obtain the engine kit from the supplier listed in A9.1.3 which contains all the necessary

A2.4 *Units for Reporting Results*—All data except roller follower shaft wear should be reported in appropriate metric units.

A2.5 *Specification Formats*—Specifications are listed in three different formats throughout the standard. Specifications which have a target and no tolerance are listed as x.xxx. For example, torque specifications are listed as 40 N·m. Specifications which have a target and a tolerance are listed as xx.xx ± x.xx. For example, engine speed is 1000 ± 5 r/min. Specifications which have ranges but no target are used when (1) the value of the parameter is not critical as long as the parameter is within the range specified or (2) the measurement technique is not precise.

A2.5.1 Specifications with a target imply the correct value is the target and the mean of a random sample representing the parameter should be equivalent to the target. The range is intended as a guide for maximum acceptable variation around the mean. Operation within the range specified does not imply that the parameter will not bias the final test results.

A2.5.1.1 A parameter with a target shall not be intentionally calibrated or controlled at a level other than the target.

consumable hardware for fifteen tests. A complete list of parts included in the kit is shown in Tables A3.1 and A3.2.

A3.7.1.1 *Critical Parts*—A critical part is any part that will impact combustion (fuel rate, injection timing, compression ratio, air flow, and oil consumption) or roller follower lubrication and loading (see Table A3.1).

TABLE A3.1 Critical Parts

Part No.	Description
	Engine assembly (6.2 or 6.5 L HD NA C/K)
	Short block assembly
10149616	Block assembly (6.2 or 6.5 L one pc seal)
14077141	Piston (NA)
14032399	Top rings
14025533	Second ring
23500288	Oil ring
14025524	Piston rod assembly (upper)
	Cylinder head assembly (HD NA 10)
10149663	Exhaust valves
14033927	Inlet valves
10230426	Prechambers (+ 10 % revolution throttle)
14025512	Valve springs
23502552	Exhaust valve stem seal
	Inlet valve stem seal
10163736	Head gasket (blue stripe)
14066308	Camshaft
23502598	Oil pan
BX-6202-1	Oil filter (Bowden)
DX-109561	Valve cover gasket (Western auto gasket)
10163737	Nozzle
10154615	Injection pump—(Arctic pump)
17109650	Lifter assembly

TABLE A3.2 Engine Test Kit

Part No.	Test Kit Item
BX-6200-1	Test kit—includes 1 each BX-6201-1, 30 each BX-6202-1 and 240 each BX-6204-1
BX-6201-1	Engine—complete with exception of front cover
BX-6202-1	Test oil filter
BX-6203-1	Front cover
BX-6204-1	Hydraulic lifter
BX-6205-1	Water cooled manifolds, left and right side
BX-6206-1	Exhaust manifold discharge flanges
BX-6207-1	Gaskets for exhaust manifold discharge flange
BX-6208-1	Studs for exhaust manifold
BX-6209-1	Time trac injection timing indicator w/¼ in. transducer
BX-6210-1	Intake air horn
BX-6212-1L	Rocker arm cover assembly, left
BX-6212-1R	Rocker arm cover assembly, right
BX-350-3	Oil separator

A3.7.2 *Specially Fabricated Engine Parts*—The following subsections detail the specially fabricated engine parts used in this test method:

A3.7.2.1 *Exhaust Manifold Discharge Flanges*—The flanges are required and are available from the supplier listed in Appendix X1.

A3.7.2.2 *Intake Air Horn*—The design, including all modifications is required. Obtain modified intake air horns from the supplier listed in Appendix X1.

A3.7.2.3 *Rocker Arm Cover*—The specially fabricated rocker arm cover is required. Obtain rocker arm covers from the supplier listed in Appendix X1.

A3.7.2.4 *Engine Front Cover*—The engine front cover is required. Obtain front covers from the supplier listed in Appendix X1.

A3.7.3 *Engine Measurement and Assembly Equipment*—Required special engine measurement and assembly equipment is described in A3.7.3.1–A3.7.3.4. Items routinely used in the laboratory and workshop are not included.

A3.7.3.1 *Injection Timing Measurement*—Measure injection timing using the indicator located on the harmonic balancer. Use a Stanadyne Time Trac injection timing measurement device. Obtain it from the supplier listed in Appendix X1.

A3.7.3.2 *Oil Flush System*—A flush system is required to flush the engine oil system between tests. The design of the system is not specified, but the reservoir should be capable of holding a minimum of 8 L of fluid.

A3.7.3.3 *Hydraulic Lifter Removal Tool*—The tool, Part No. J-29834, is not required, but it facilitates the removal of the hydraulic lifters from the engine. Information concerning tool acquisition is shown in Appendix X1.

A3.7.3.4 *Wear Measurement Device*—Use a skidless stylus type measuring device to measure the wear on the roller follower shafts.

A3.7.4 *Miscellaneous Equipment:*

A3.7.4.1 *Used Oil Sample Containers*

Containers are necessary to obtain and store used oil samples. High density polyethylene containers (120 mL) are recommended for oil samples. (**Warning**—In addition to other precautions, glass containers are fragile and may cause injury or exposure to hazardous materials, if broken.)

A3.8 *Test Stand Configuration and Control Systems:*

A3.8.1 *Engine Speed, Load and Fuel Consumption Rate Control Systems*—Engine speed, load, and fuel consumption rate control systems shall be capable of maintaining the limits specified in Table 1. Speed, load, and fuel consumption rate and parameters affecting air flow through the engine are interactive. Engine speed is typically controlled by varying dynamometer excitation, while engine fuel consumption rate and load are altered by varying the throttle position. Typical laboratory practices to control load and fuel consumption rate include fixed throttle position or closed-loop, feedback control systems.

A3.8.2 *Fuel Supply System*—The design is not specified, but the system shall be capable of controlling fuel temperature according to the specification shown in Table 1. Maintain fuel transfer pressure above 45 kPa.

A3.8.3 *Intake Air System*—Configure the air supply system according to the schematic diagram shown in Fig. A3.1. Fabricate a Piezometer ring according to Fig. A3.1. The control system shall be capable of maintaining the intake-air temperature and pressure specifications shown in Table 1.

A3.8.4 *Engine Coolant System*—A suggested cooling system is shown in the schematic diagram A3.5. The Barco flow meter is the only required component.

A3.8.5 *Exhaust Manifold Coolant System*—Maintain the outlet water temperature of the water cooled manifolds below 60°C. Water-cooled exhaust plumbing downstream of the exhaust probes is a typical laboratory practice. Exhaust system design downstream of the water cooled manifold discharge flanges is not specified. (**Warning**—Good engineering practices should be utilized to ensure safe operation of this system. High temperature, low water flow, or low water pressure alarms, or both, are recommended to prevent damage due to lack of cooling during engine operation.)

A3.8.6 *External Oil System*—Configure the external oil system according to the schematic diagram shown in Fig. A3.2. Install –8 lines to and from the oil cooler. Install a sample valve and a connection for the flush system to the line returning oil from the cooler. Performance specifications are shown in Table 1.

A3.8.7 *Crankcase Ventilation System*—Configure the crankcase ventilation system as shown in Fig. A3.3.

A3.8.8 *Drive Line Configuration*—Configure the engine mounting so that the crankshaft is horizontal. The engine cannot be used to drive any external engine accessory.

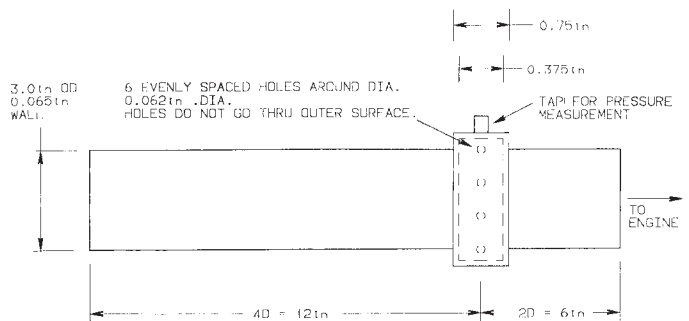

FIG. A3.1 Air Intake Piezometer Ring

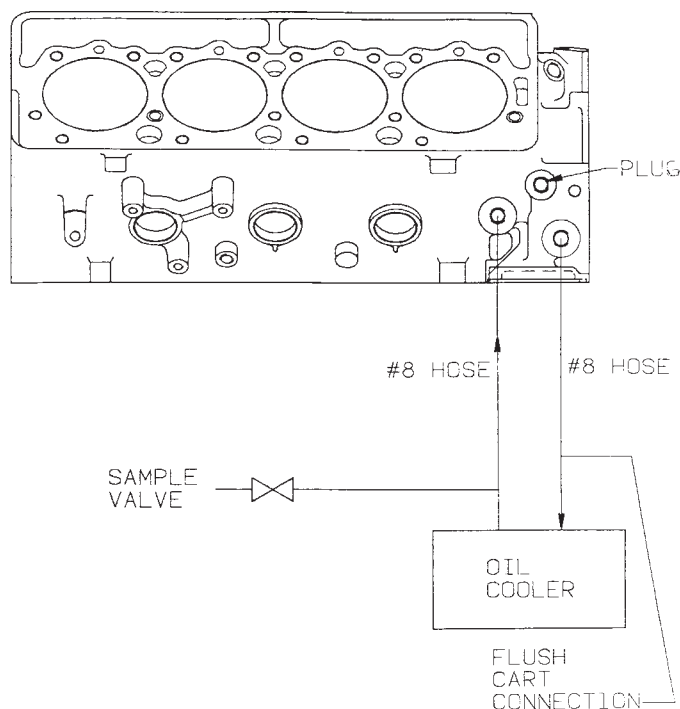

FIG. A3.2 External Oil Cooling System

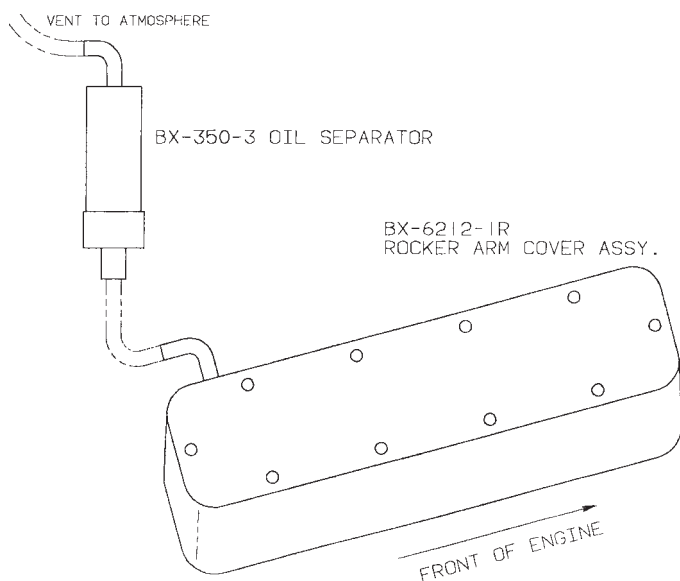

FIG. A3.3 Crankcase Ventilation System

A3.8.9 *Engine Starting Motor*—Air driven starter motors are strongly recommended because of the 2 min engine cranking time during the oil flush procedure.

A3.9 *Measurement Transducers and Systems:*

A3.9.1 *Engine Speed Measurement*—Engine speed is typically measured using a pulsed (magnetic pick-up based) system.

A3.9.1.1 *Engine Speed Measurement Calibration*—Calibrate the engine speed measurement and readout system before each calibration test.

A3.9.2 *Engine Load Measurement*—Measure engine load with a load cell attached to the dynamometer torque arm.

A3.9.2.1 *Engine Load Measurement Calibration*—Span the load measurement and readout system with deadweights before each engine calibration test. This may be done more frequently as needed.

A3.9.3 *Temperature Measurement Equipment:*

A3.9.3.1 Temperature measurement equipment and locations for the five required temperatures are specified. Alternative temperature measurement equipment shall be approved by the TMC. The accuracy and resolution of the temperature measurement sensors and the complete temperature measurement system shall follow the guidelines detailed in the research report.³

A3.9.3.2 All thermocouples shall be premium, sheathed, grounded types with premium wire. All thermocouples, with the exception of the engine exhaust temperature thermocouples, shall be 1/8 in. diameter. The engine exhaust temperature thermocouples shall be 1/8 in. or 1/4 in. diameter. Match thermocouples, wires, and extension wires to perform in accordance with the special limits of error as defined in ANSI MC96.1.

A3.9.3.3 *Coolant Inlet*—Install the tip at the center of the flow stream just before the flow is split into the right and left bank of the engine.

A3.9.3.4 *Coolant Outlet*—Install the tip to a depth of approximately 100 mm at the center of the flow stream in a thermostat housing tapped to accept a 1/8-in. diameter thermocouple.

A3.9.3.5 *Fuel Inlet*—Install the tip in a 1/4-in. diameter tee at the center of the flow stream approximately 50 mm upstream of the fuel filter, located behind the intake manifold.

A3.9.3.6 *Oil Gallery*—Remove the oil pressure sending unit which is located on the left rear on the top of the block. Install a 1/4-in. diameter NPT pipe closed nipple in the engine block. Install a 1/4-in. diameter thermocouple into the nipple. Install the thermocouple tip until it bottoms out in the oil gallery and back the thermocouple out approximately 6 mm. The installation depth will be about 150 mm.

A3.9.3.7 *Oil Sump*—Locate the thermocouple on the right side of the sump, approximately 50 mm from the bottom, and 150 mm from the rear. Install the tip approximately 75 mm into the sump.

A3.9.3.8 *Intake Air*—Install the tip midstream in the intake-air horn approximately 25 mm downstream of the inlet of the intake-air horn. This is approximately 200 mm downstream from the Piezometer ring as shown in Fig. A3.1.

A3.9.3.9 *Exhaust Gas*—Install the thermocouple into the bottom port on each water cooled manifold discharge flange.

A3.9.3.10 *Temperature Measurement Calibration*—Calibrate all thermocouples and temperature measurement systems before each calibration test. Each temperature measurement system shall indicate within ±0.5°C of the laboratory calibration standard. The calibration standard shall be traceable to national standards.

A3.9.4 *Pressure Measurement Equipment*—Requirements for pressure measurement are detailed in the following sections. Specific measurement equipment is not specified. This allows reasonable opportunity for adaptation of existing test stand instrumentation. However, the accuracy and resolution of

the pressure measurement sensors and the complete pressure measurement system shall follow the guidelines detailed in ASTM Research Report RR:D02-1218.³

A3.9.4.1 Operate pressure measurement transducers in a temperature controlled environment with a maximum temperature variation of $\pm 3^{\circ}\text{C}$ to prevent calibration drift. (**Warning**—Tubing between the pressure tap locations and the final pressure sensors should incorporate condensate traps as necessary by good engineering practice. This is particularly important in applications where low air pressures are transmitted by way of lines which pass through low-lying trenches between the test stand and the instrument console.)

A3.9.4.2 *Oil Pressure*— Measure oil pressure at the tee installed in place of the oil pressure sending unit, located at the left, rear of the engine (see A3.9.3.6).

A3.9.4.3 *Intake-Air Pressure*—Measure the intake-air pressure by way of a 1/4 in. diameter pressure tap mounted in a Piezometer ring on the intake air system (see Fig. A3.1).

A3.9.4.4 *Crankcase Pressure*—Measure the crankcase pressure at the dipstick tube.

A3.9.4.5 *Exhaust Back Pressure*—Locate the exhaust back pressure taps on the top of each water cooled manifold discharge flange. Tie both taps together. A sensor capable of absolute measurement is required. A condensate trap should be installed between the probe and sensor to accumulate water present in the exhaust gas.

A3.9.4.6 *Coolant System Pressure*—Measure the coolant system pressure at the top of the expansion tank as detailed in Fig. A3.4.

A3.9.4.7 *Fuel Pressure*— Measure fuel pressure upstream of the location of the fuel inlet thermocouple.

A3.9.4.8 *Pressure Measurement Calibration*—Calibrate all pressure transducer and measurement systems before each calibration test. Calibrate pressure measurement transducers in a temperature controlled environment. The calibration temperature shall be the same nominal value as the temperature in which the transducers are operated during testing.

A3.9.5 *Flow Rate Measurement Equipment*—Flow rate measurement for the required parameters is detailed in the following subsections. Measurement equipment is only specified for engine coolant flow rate. This allows reasonable opportunity for adaptation of existing test stand instrumentation. The accuracy and resolution of the flow rate measurement

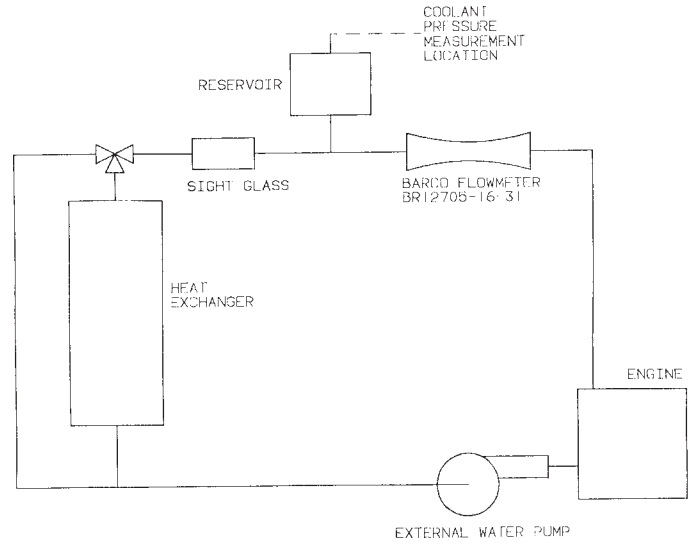

FIG. A3.4 Engine Coolant System

system shall follow the guidelines detailed in ASTM Research Report RR:D02-1218.³

A3.9.5.1 *Coolant Flow Rate*—Determine the engine coolant flow rate by measuring the differential pressure across the specified venturi flow meter (see Fig. A3.5). The pressure drop is approximately 5.0 kPa in the controlled flow range. Take precautions to prevent air pockets from forming in the lines to the pressure sensor. Transparent lines and bleed lines are beneficial in this application.

A3.9.5.2 *Coolant Flow Rate Calibration*—Calibrate the engine coolant flow meter before each calibration test as installed in the system at the test stand. Alternatively, the flow meter may be detached from the test stand and calibrated, providing the adjacent upstream and downstream plumbing is left intact during the calibration process. Calibrate the flow against a turbine flow meter or by a volume/time method.

A3.9.5.3 *Fuel Consumption Rate*—Determine the fuel consumption rate by measuring the rate of fuel flowing to the day tank.

A3.9.5.4 *Fuel Consumption Rate Measurement Calibration*—Calibrate fuel consumption rate measurement before every calibration test. Volumetric systems shall be temperature-compensated and calibrated against a mass flow device. The flow meter located on the test stand shall indicate within 0.2 % of the calibration standard.

A4. CALIBRATION

A4.1 *Organization of Calibration Description Sections*— Calibration is divided into two categories—measurement system calibration and test/engine calibration. Details on measurement system calibration are shown with each system or device in A3. A summary of calibration frequency for measurement systems and a cross reference to the corresponding apparatus section is shown in Table A4.1.

A4.2 Details on test engine/stand calibration are shown in A4.3.

TABLE A4.1 Measurement System Calibration Frequency

Measurement System	Calibration Frequency	Section Reference
Temperature	before each calibration test	A3.9.3.10
Pressure	before each calibration test	A3.9.4.7
Engine coolant flow	before each calibration test	A3.9.5.2
Fuel flow	before each calibration test	A3.9.5.4
Engine speed	before each calibration test	A3.9.1.1
Dynamometer load	before each calibration test	A3.9.2.1

A4.3 *Test Engine/Stand Calibration*—Calibrate the test

stand and engine as a unit by running a 50-h steady state test after an engine has completed the break-in with a reference oil supplied by the TMC. The TMC will use the Lubricant Test Monitoring System (LTMS) to judge operationally valid calibration test results. (A document describing the LTMS is available from the TMC.) If the calibration test results are within the LTMS limits, then the test stand is considered to be calibrated. A calibrated engine cannot be removed from the test stand on which it was calibrated without invalidating the remainder of the calibration period.

A4.3.1 Test Engine/Stand Calibration Period—Each test engine kit has a total life of fifteen tests (both non-reference and calibration tests are included in the test count). An engine/stand is considered calibrated for 9 months or until the completion of the fifteenth test on the engine kit. Calibration time periods may be adjusted by the TMC. Any deviation from the standard calibration time frequency shall be approved by the TMC and reported in the comment section of the Unscheduled Downtime and Maintenance Summary (see Annex A5) of the final test report. Any non-reference test started within 9 months of the completion date of the previous calibration test is considered within the calibration time period.

A4.3.1.1 Modification of test stand control systems or completion of any non-standard test on a calibrated stand shall be reported to the TMC immediately. A non-standard test includes any test completed under a modified procedure requiring hardware or controller set-point modifications to the test stand. The TMC will determine whether another calibration test is necessary after the modifications have been completed.

A4.3.2 Unacceptable Calibration Results—Failure of a calibration test to meet LTMS control chart limits can be indicative of a false alarm, testing stand, testing laboratory, or industry related problem. When this occurs, the laboratory, in conjunction with the TMC, shall attempt to determine the problem source. If it is determined to be a false alarm or testing stand problem, there is no impact on non-reference tests running in other testing stands within that laboratory. If it is determined that the problem is laboratory related, non-

reference tests running during the problem period shall be considered invalid unless there is specific evidence to the contrary for each individual test. Industry problems shall be adjudicated by the Surveillance Panel.

A4.3.3 Reference Oil Accountability—Laboratories conducting calibration tests are required to provide a full accounting of the identification and quantities of all reference oils used. With the exception of the new oil analysis required in 10.3, no physical or chemical analysis of new reference oils may be performed without permission from the TMC.

A4.3.4 Used Reference Oil and Used Calibration Test Parts Storage—Retain all samples of used reference oil for 90 days. Retain each roller follower shaft from a calibration test for six months.

A4.3.5 Test Numbering System:

A4.3.5.1 Acceptable Tests—The test number shall follow the format AAA-BBB-CCC-DD. AAA represents the stand number. BBB represents the number of tests run on a particular stand. CCC represents the engine kit number. DD represents the number of tests run on a particular engine. As an example, 6-40-21-8 represents the fortieth test on Stand 6 and the eighth test on Engine Kit 21. Please note, all tests on a given stand shall be consecutively numbered.

A4.3.5.2 Unacceptable or Aborted Tests—If a calibration test is aborted or the results are outside the acceptance limits, the BBB portion of the test number for subsequent calibration test(s) will include a letter suffix. The suffix will begin with the letter A and continue alphabetically until a calibration test is completed within the acceptance limits. For example, if three consecutive unacceptable calibration tests are completed on the same test stand and the test number of the first test is 6-40-21-8, the next two test numbers would be 6-40A-21-9 and 6-40B-21-10. If the results of the next calibration test are acceptable, the test number 6-40C-21-11 would permanently identify the test and appear on future correspondence. The completion of any amount of operational time on tests other than calibration tests will cause the test number to be increased by one. No letter suffix will be added to the test number of tests other than calibration tests.

A5. FINAL REPORT FORMS

A5.1 Figs. A5.1-A5.21 are sample report forms.

ROLLER FOLLOWER WEAR TEST
VERSION 19960828

CONDUCTED FOR

TSTSPON1

TSTSPON2

<i>LABVALID</i>	V = VALID
	I = INVALID

Test Number			
Test Stand <i>STAND</i>	Stand Run Number: <i>RSTRUN/STRUN</i>	Engine <i>ENGINE</i>	Engine Run Number: <i>RENUN/ENRUN</i>
Date Completed: <i>RDTCOMP/DTCOMP</i>		EOT Time: <i>REOTIME/EOTTIME</i>	
Oil Code ^A : <i>OILCODE/CMIR</i>			
Formulation/Stand Code: <i>FORM</i>			
Alternate Codes:	<i>ALTCODE1</i>	<i>ALTCODE2</i>	<i>ALTCODE3</i>

^A CMIR or Non-Reference Oil Code

SUBMITTED BY: _____ *SUBLAB*
 _____ Testing Laboratory
 _____ *SUBSIGM*
 _____ Signature
 _____ *SUBNAME*
 _____ Typed Name
 _____ *SUBTITLE*
 _____ Title

FIG. A5.1 Final Report Cover Sheet

ROLLER FOLLOWER WEAR TEST

REFERENCE OIL TEST					NON-REFERENCE OIL TEST				
LAB	STAND	STAND RUN #	ENGINE	ENGINE RUN #	LAB	STAND	STAND RUN #	ENGINE	ENGINE RUN #
<i>LAB</i>	<i>STAND</i>	<i>RSTRUN</i>	<i>ENGINE</i>	<i>RENUN</i>	<i>LAB</i>	<i>STAND</i>	<i>STRUN</i>	<i>ENGINE</i>	<i>ENRUN</i>
START DATE	DATE COMPLETED	END OF TEST TIME	TEST LENGTH		START DATE	DATE COMPLETED	END OF TEST TIME	TEST LENGTH	
<i>RDSTRT</i>	<i>RDTCOMP</i>	<i>REOTIME</i>	<i>REOTLEN</i>		<i>DSTRT</i>	<i>DTCOMP</i>	<i>EOTIME</i>	<i>ESTLEN</i>	
CMIR	TMC OIL CODE		VISCOSITY GRADE		OILCODE				VISCOSITY GRADE
<i>CMIR</i>	<i>IND</i>		<i>SAEVISC</i>		<i>OILCODE</i>				<i>SAEVISC</i>
LABORATORY OIL CODE			LABORCOOD		LABORATORY OIL CODE			LABORCOOD	
ENGINE DISPLACEMENT			ENGINL		FORMULATION STAND CODE				
FORM					FORM				
AVERAGE WEAR (MILS)					AVERAGE WEAR (MILS)	SEVERITY ADJUSTMENT	ADJUSTMENT AVERAGE WEAR		
<i>WEAR</i>					<i>WEAR</i>	<i>WEARL</i>	<i>WEARINC</i>		

FIG. A5.2 Test Lab Affidavit

Laboratory	<i>LAB</i>	EOT Date	<i>RDTCOMP/DTCOMP</i>
Test Number	<i>STAND - RSTRUN/STRUN - ENGINE - RENRUN/ENRUN</i>	Oil Code	<i>OILCODE/CMIR</i>
Formulation/Stand Code	<i>FORM</i>		

Lifter Part Number:
<i>LIFTPNI</i>

PROFILOMETER WEAR MEASUREMENTS IN MILS

Lifter Number	Wear (MILS)	Lifter Number	Wear (MILS)
1L	<i>WEAR1L</i>	1R	<i>WEAR1R</i>
2L	<i>WEAR2L</i>	2R	<i>WEAR2R</i>
3L	<i>WEAR3L</i>	3R	<i>WEAR3R</i>
4L	<i>WEAR4L</i>	4R	<i>WEAR4R</i>
5L	<i>WEAR5L</i>	5R	<i>WEAR5R</i>
6L	<i>WEAR6L</i>	6R	<i>WEAR6R</i>
7L	<i>WEAR7L</i>	7R	<i>WEAR7R</i>
8L	<i>WEAR8L</i>	8R	<i>WEAR8R</i>
WEAR STATISTICS			
Minimum	Maximum	Average	Std. Deviation
<i>IWEAR</i>	<i>XWEAR</i>	<i>RWEAR/WEAR</i>	<i>SWEAR</i>

Wear is measured at location shown by arrow.

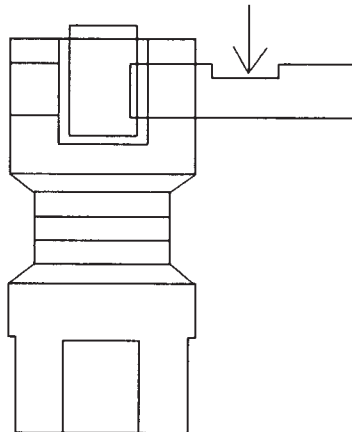

FIG. A5.3 Summary of Roller Follower Wear

Laboratory	<i>LAB</i>	EOT Date	<i>RDTCOMP/DTCOMP</i>
Test Number	<i>STAND - RSTRUN/STRUN - ENGINE - RENRUN/ENRUN</i>	Oil Code	<i>OILCODE/CMIR</i>
Formulation/Stand Code	<i>FORM</i>		

ENGINE SPEED (r/min)

PROCESS MEAN

$X_{av} = PMRPM$

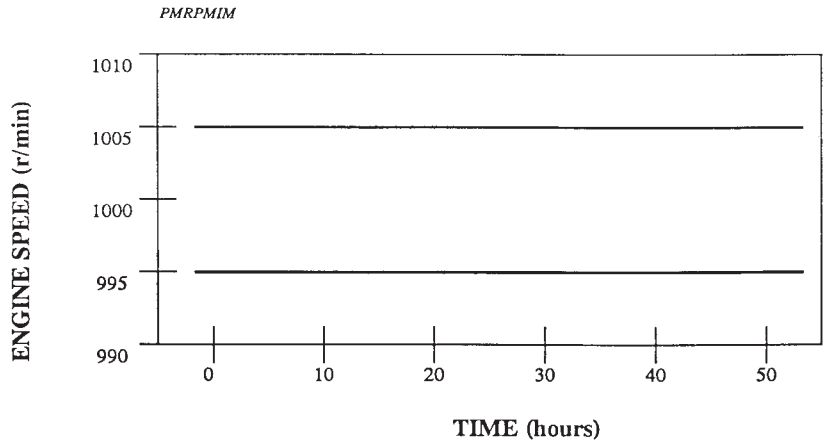

PROCESS VARIABILITY (s)

$S_{av} = PVRPM$

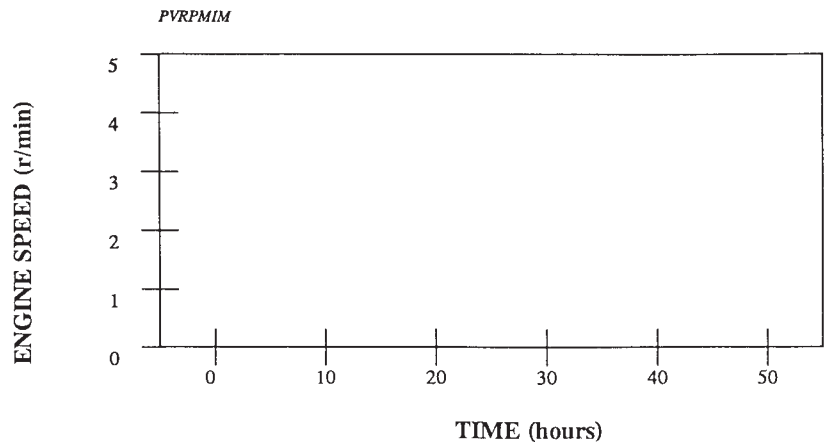

FIG. A5.4 Operational Data Summary—Engine Speed

Laboratory	<i>LAB</i>	EOT Date	<i>RDTCOMP/DTCOMP</i>
Test Number	<i>STAND - RSTRUN/STRUN - ENGINE - RENRUN/ENRUN</i>	Oil Code	<i>OILCODE/CMIR</i>
Formulation/Stand Code	<i>FORM</i>		

FUEL FLOW (kg/h)

PROCESS MEAN

$X_{av} = PMFFLO$

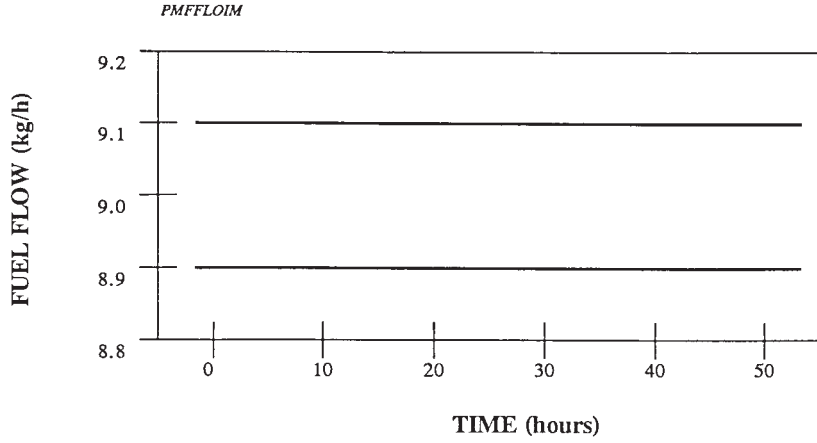

PROCESS VARIABILITY (s)

$S_{av} = PVFFLO$

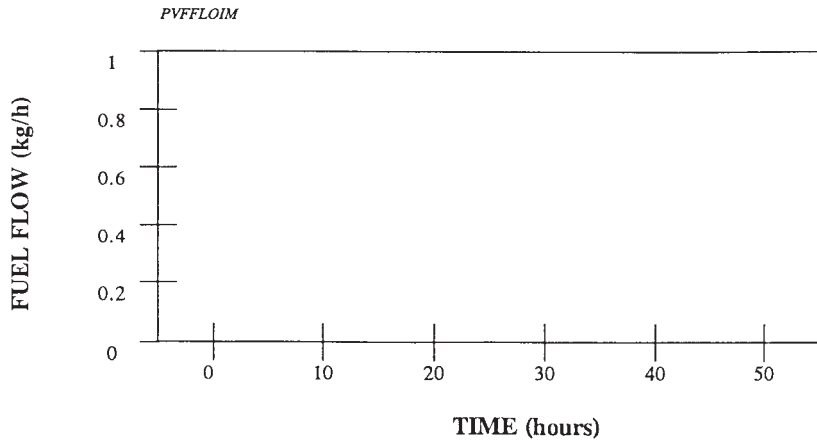

FIG. A5.5 Operational Data Summary—Power

**ROLLER FOLLOWER WEAR TEST
Form 5 - Operational Data Summary**

Laboratory	<i>LAB</i>	EOT Date	<i>RDTCOMP/DTCOMP</i>
Test Number	<i>STAND - RSTRUN/STRUN - ENGINE - RENRUN/ENRUN</i>	Oil Code	<i>OILCODE/CMIR</i>
Formulation/Stand Code	<i>FORM</i>		

FUEL FLOW (kg/h)

PROCESS MEAN

$X_{av} = PMFFLO$

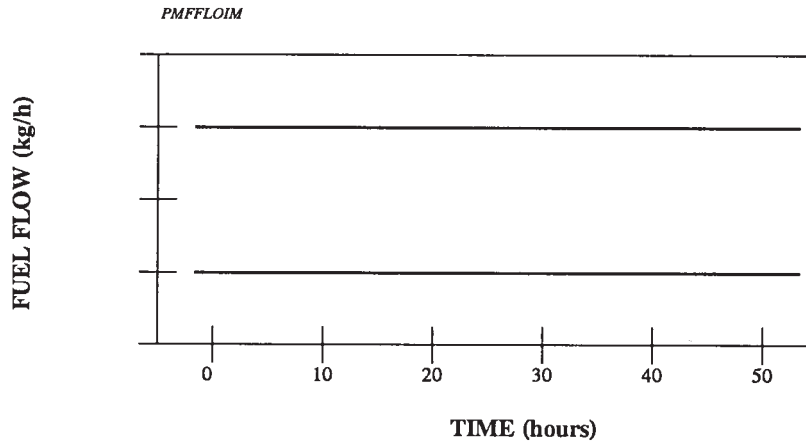

PROCESS VARIABILITY (s)

$S_{av} = PVFFLO$

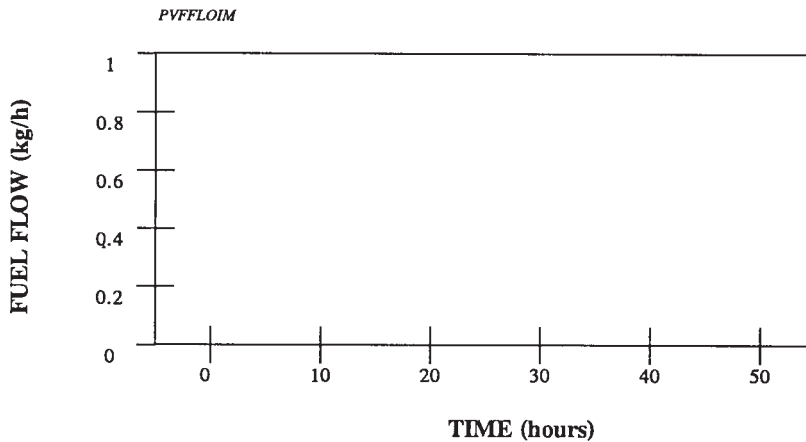

FIG. A5.6 Operational Data Summary—Fuel Flow

Laboratory	<i>LAB</i>	EOT Date	<i>RDTCOMP/DTCOMP</i>
Test Number	<i>STAND - RSTRUN/STRUN - ENGINE - RENRUN/ENRUN</i>	Oil Code	<i>OILCODE/CMIR</i>
Formulation/Stand Code	<i>FORM</i>		

COOLANT OUT TEMPERATURE

PROCESS MEAN

$X_{av} = PMCOLOUT$

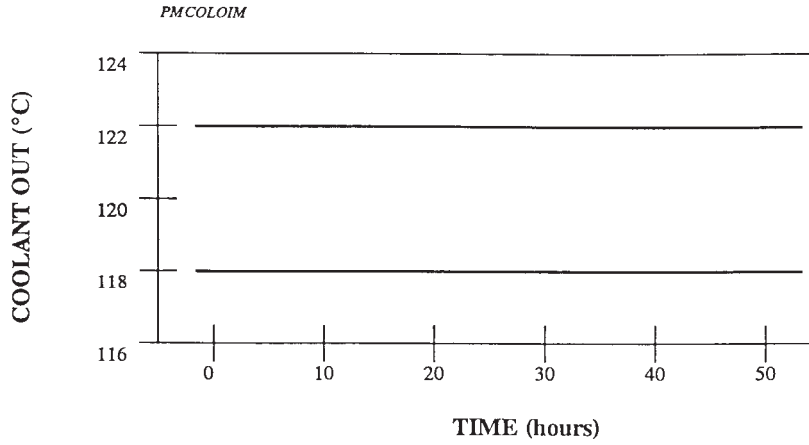

PROCESS VARIABILITY (s)

$S_{av} = PVCOLOUT$

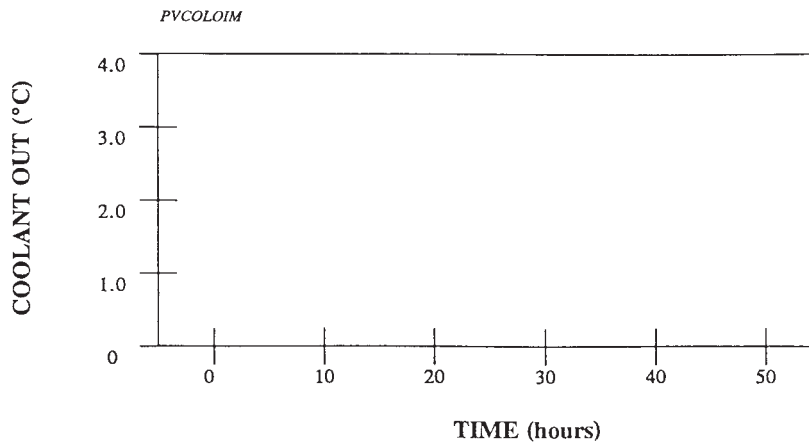

FIG. A5.7 Operational Data Summary—Coolant Out Temperature

Laboratory	<i>LAB</i>	EOT Date	<i>RDTCOMP/DTCOMP</i>
Test Number	<i>STAND - RSTRUN/STRUN - ENGINE - RENRUN/ENRUN</i>	Oil Code	<i>OILCODE/CMIR</i>
Formulation/Stand Code	<i>FORM</i>		

COOLANT INLET TEMPERATURE

PROCESS MEAN

$X_{av} = PMCOLIN$

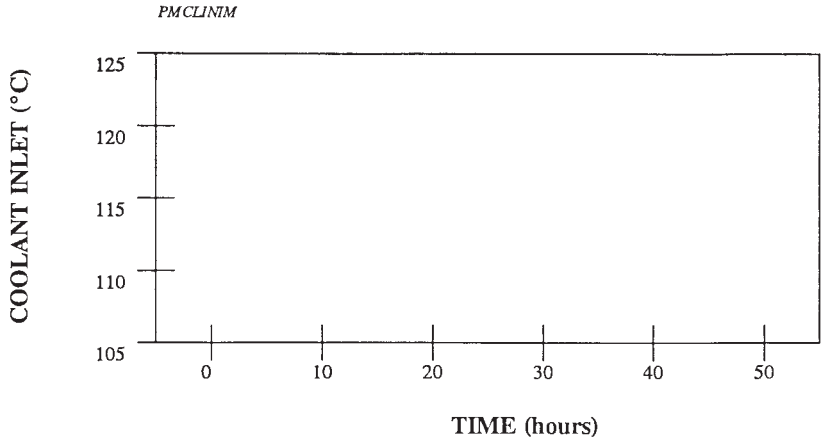

PROCESS VARIABILITY (s)

$S_{av} = PVMOLIN$

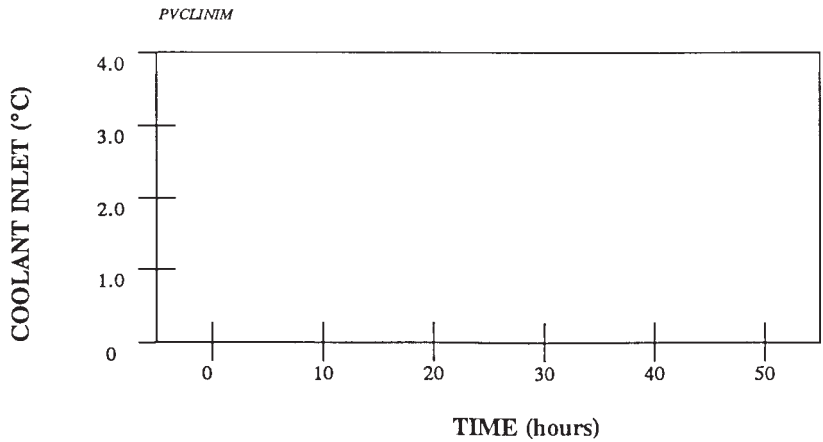

FIG. A5.8 Operational Data Summary—Coolant Inlet Temperature

Laboratory	<i>LAB</i>	EOT Date	<i>RDTCOMP/DTCOMP</i>
Test Number	<i>STAND - RSTRUN/STRUN - ENGINE - RENRUN/ENRUN</i>	Oil Code	<i>OILCODE/CMIR</i>
Formulation/Stand Code	<i>FORM</i>		

OIL GALLERY TEMPERATURE

PROCESS MEAN

$X_{av} = P_{MOILGAL}$

P_{MOGALIM}

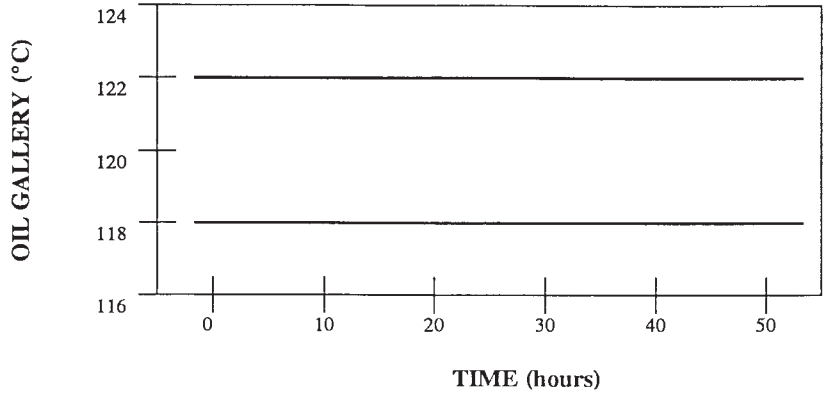

PROCESS VARIABILITY (s)

$S_{av} = P_{VOILGAL}$

P_{VOGALIM}

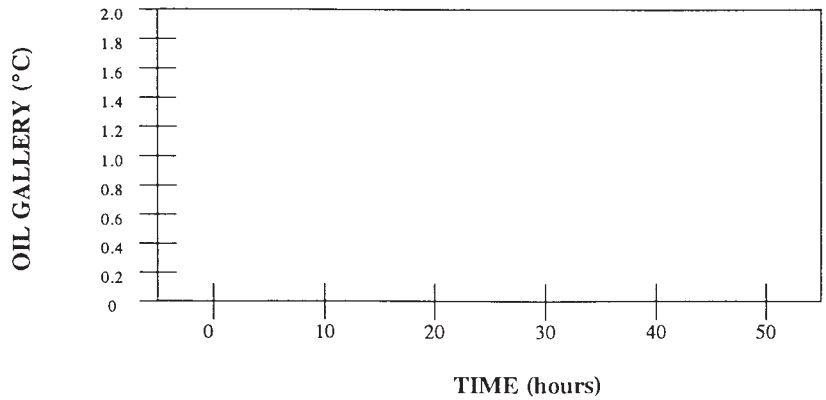

FIG. A5.9 Operational Data Summary—Oil Gallery Temperature

Laboratory	<i>LAB</i>	EOT Date	<i>RDTCOMP/DTCOMP</i>
Test Number	<i>STAND - RSTRUN/STRUN - ENGINE - RENRUN/ENRUN</i>	Oil Code	<i>OILCODE/CMIR</i>
Formulation/Stand Code		<i>FORM</i>	

OIL GALLERY PRESSURE

PROCESS MEAN

$X_{av} = PMOILGPR$

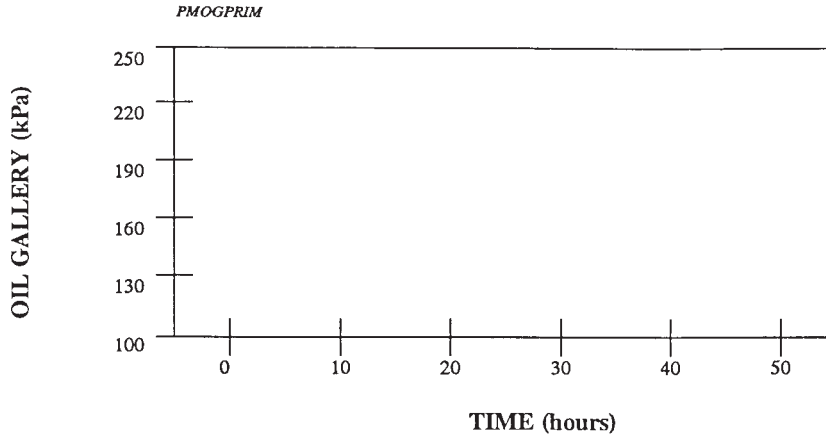

PROCESS VARIABILITY (s)

$S_{av} = PVOILGPR$

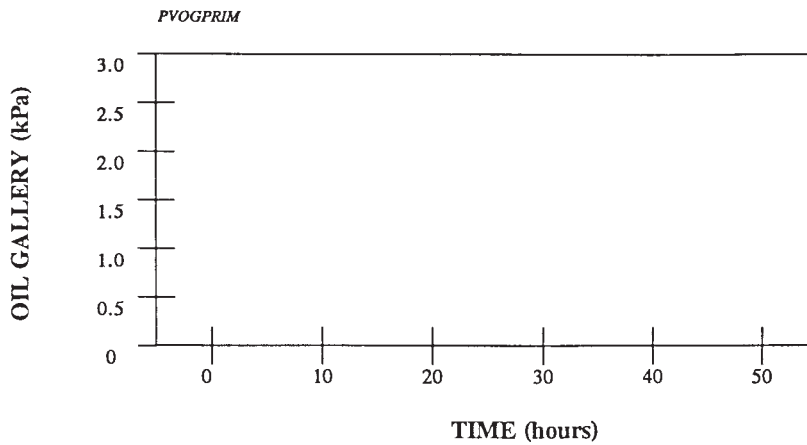

FIG. A5.10 Operational Data Summary—Oil Gallery Pressure

Laboratory	<i>LAB</i>	EOT Date	<i>RDTCOMP/DTCOMP</i>
Test Number	<i>STAND - RSTRUN/STRUN - ENGINE - RENRUN/ENRUN</i>	Oil Code	<i>OILCODE/CMIR</i>
Formulation/Stand Code	<i>FORM</i>		

INTAKE AIR TEMPERATURE

PROCESS MEAN

$X_{av} = P_{MINAIR}$

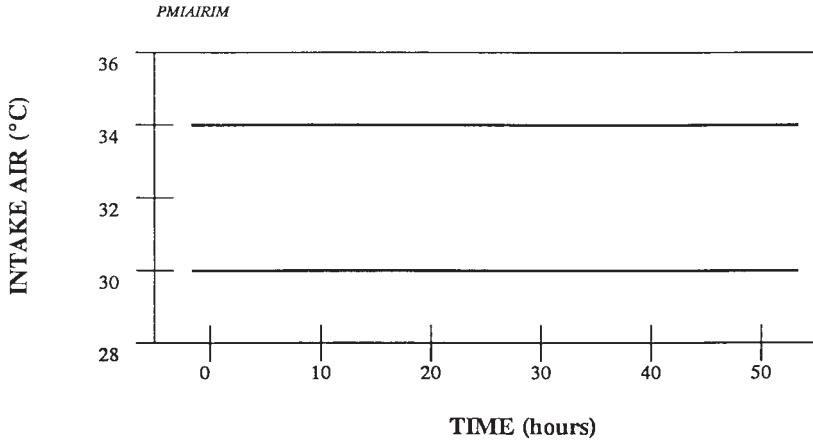

PROCESS VARIABILITY (s)

$S_{av} = P_{VINAIR}$

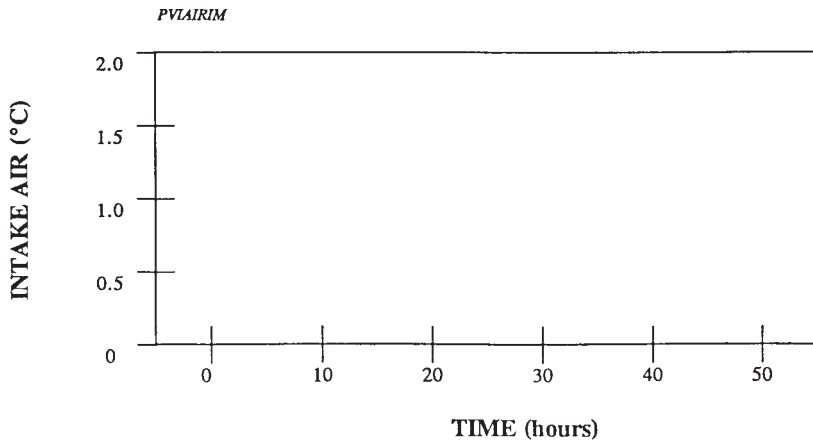

FIG. A5.11 Operational Data Summary—Intake Air Temperature

Laboratory	<i>LAB</i>	EOT Date	<i>RDTCOMP/DTCOMP</i>
Test Number	<i>STAND - RSTRUN/STRUN - ENGINE - RENRUN/ENRUN</i>	Oil Code	<i>OILCODE/CMIR</i>
Formulation/Stand Code	<i>FORM</i>		

CRANKCASE PRESSURE

PROCESS MEAN

$X_{av} = PMCCPR$

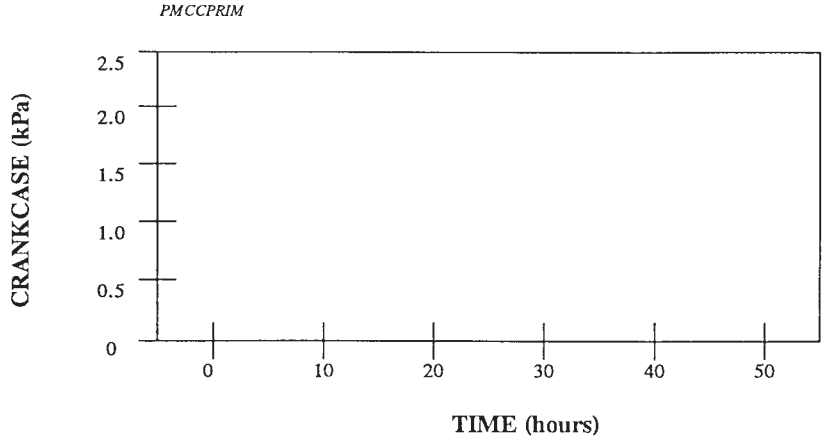

PROCESS VARIABILITY (s)

$S_{av} = PVCCPR$

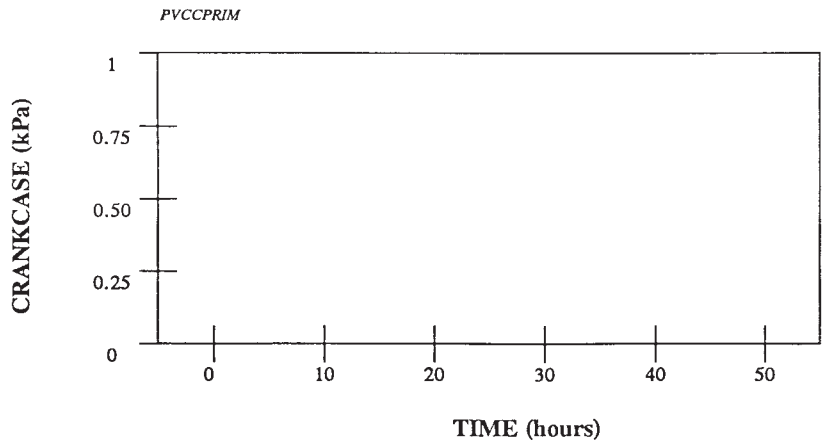

FIG. A5.12 Operational Data Summary—Crankcase Pressure

Laboratory	<i>LAB</i>	EOT Date	<i>RDTCOMP/DTCOMP</i>
Test Number	<i>STAND - RSTRUN/STRUN - ENGINE - RENRUN/ENRUN</i>	Oil Code	<i>OILCODE/CMIR</i>
Formulation/Stand Code	<i>FORM</i>		

INTAKE AIR PRESSURE

PROCESS MEAN

$X_{av} = P_{MINAIRP}$

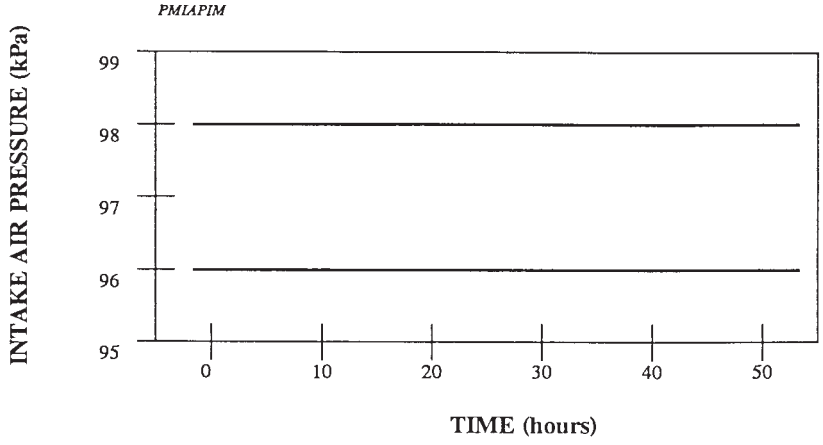

PROCESS VARIABILITY (s)

$S_{av} = P_{VINAIRP}$

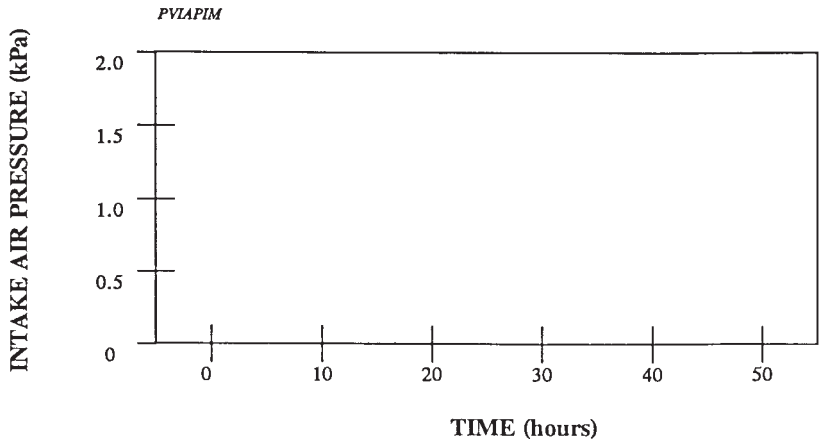

FIG. A5.13 Operational Data Summary—Intake Air Pressure

Laboratory	<i>LAB</i>	EOT Date	<i>RDTCOMP/DTCOMP</i>
Test Number	<i>STAND - RSTRUN/STRUN - ENGINE - RENRUN/ENRUN</i>	Oil Code	<i>OILCODE/CMIR</i>
Formulation/Stand Code	<i>FORM</i>		

EXHAUST BACK PRESSURE

PROCESS MEAN

$X_{av} = PMEXHBP$

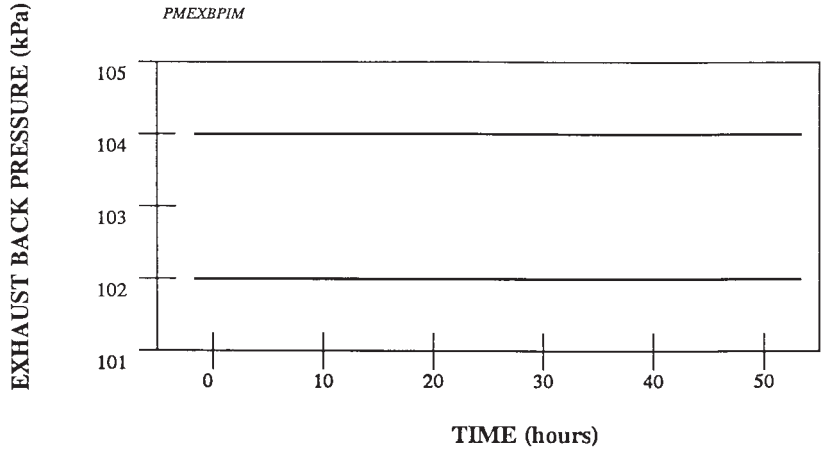

PROCESS VARIABILITY (s)

$S_{av} = PVEXHBP$

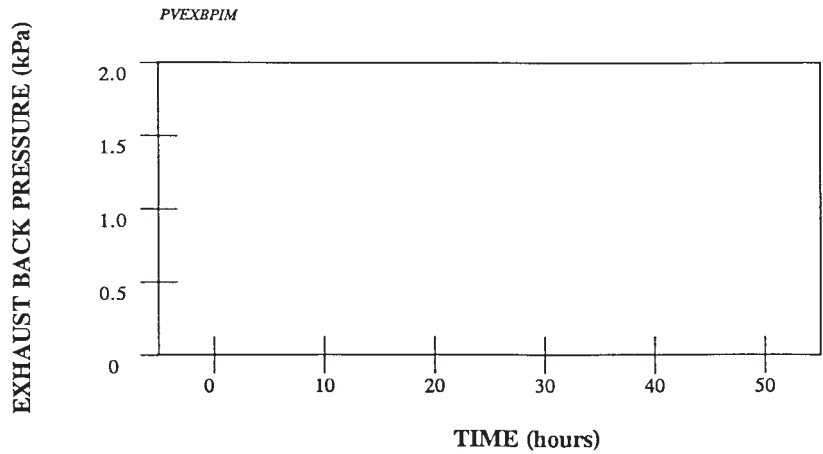

FIG. A5.14 Operational Data Summary—Exhaust Back Pressure

Laboratory	<i>LAB</i>	EOT Date	<i>RDTCOMP/DTCOMP</i>
Test Number	<i>STAND - RSTRUN/STRUN - ENGINE - RENRUN/ENRUN</i>	Oil Code	<i>OILCODE/CMIR</i>
Formulation/Stand Code	<i>FORM</i>		

FUEL INLET TEMPERATURE

PROCESS MEAN

$X_{av} = PMFUELIN$

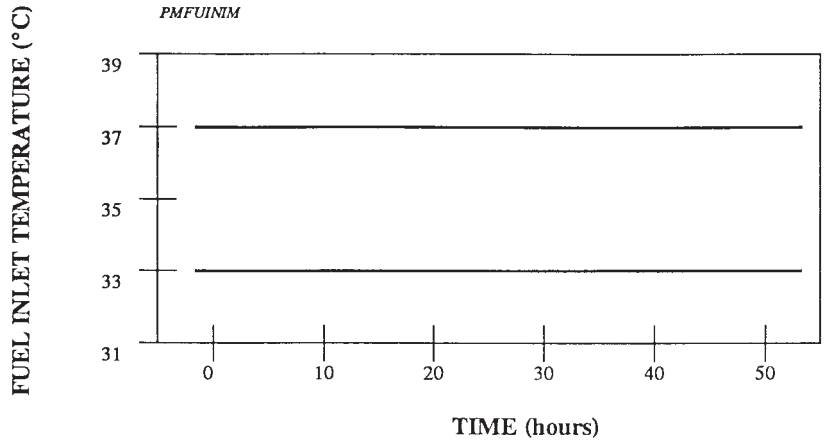

PROCESS VARIABILITY (s)

$S_{av} = PVFUELIN$

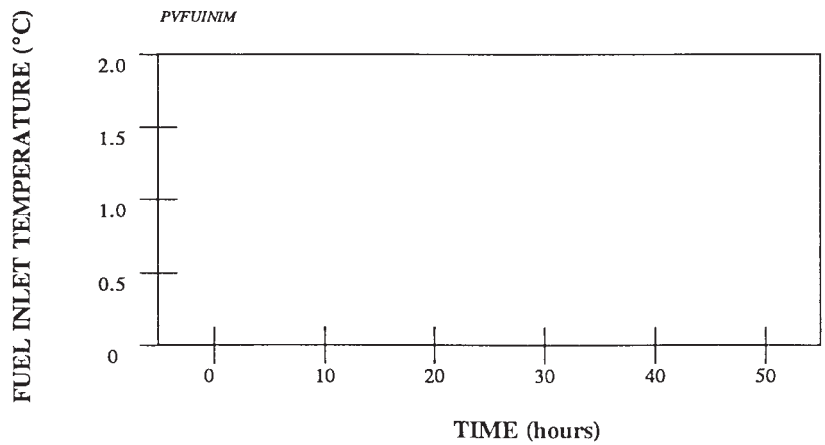

FIG. A5.15 Operational Data Summary—Fuel Inlet Temperature

Laboratory	<i>LAB</i>	EOT Date	<i>RDTCOMP/DTCOMP</i>
Test Number	<i>STAND - RSTRUN/STRUN - ENGINE - RENRUN/ENRUN</i>	Oil Code	<i>OILCODE/CMIR</i>
Formulation/Stand Code	<i>FORM</i>		

EXHAUST TEMPERATURE

PROCESS MEAN

$X_{av} = PMEXHT$

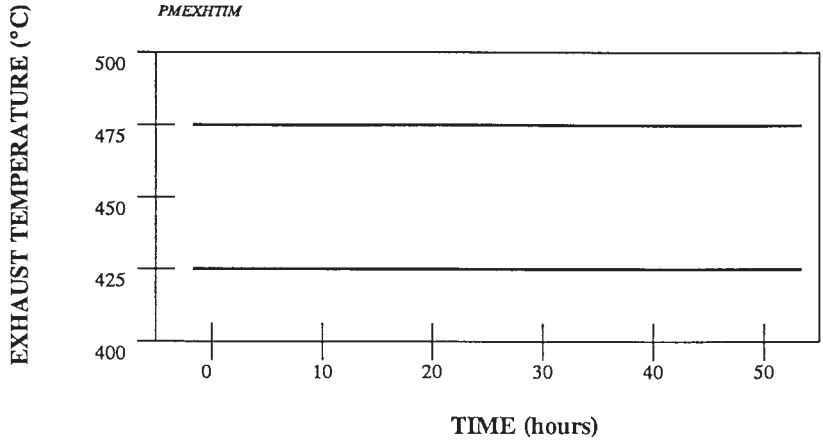

PROCESS VARIABILITY (s)

$S_{av} = PVEXHT$

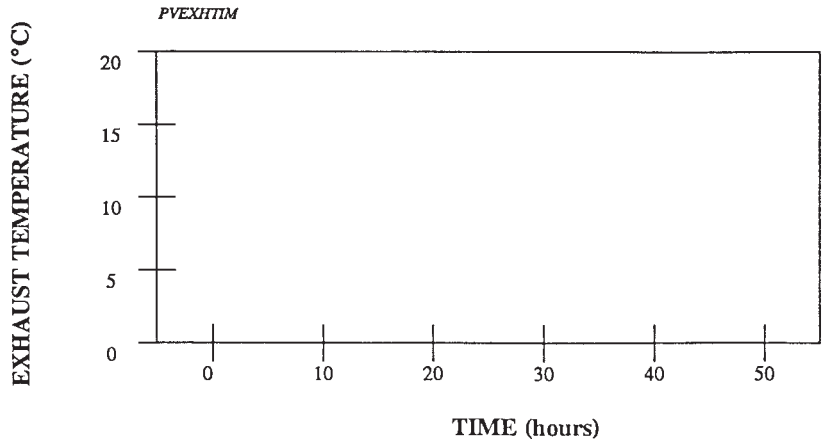

FIG. A5.16 Operational Data Summary—Exhaust Temperature



D 5966 – 02

ROLLER FOLLOWER WEAR TEST Form 16 - Operational Summary

Laboratory	<i>LAB</i>	EOT Date	<i>RDTCOMP/DTCOMP</i>
Test Number	<i>STAND - RSTRUN/STRUN - ENGINE - RENRUN/ENRUN</i>	Oil Code	<i>OILCODE/CMIR</i>
Formulation/Stand Code		<i>FORM</i>	

*TEST NUMBER IS: STAND - STAND RUN NO. - ENGINE NO. - ENGINE RUN NUMBER

SPECIFICATION						
TEST PARAMETER	6.2L Engine	6.5L Engine	AVERAGE	STD. DEV.	MINIMUM	MAXIMUM
Engine Speed r/min	1000 ± 5	1000 ± 5	<i>ARPM</i>	<i>SRPM</i>	<i>IRPM</i>	<i>XRPM</i>
Torque N-m	Record	Record	<i>ALOAD</i>	<i>SLOAD</i>	<i>ILOAD</i>	<i>XLOAD</i>
Fuel Flow kg/h	9.0 ± 0.1	9.4 ± 0.1	<i>AFFLO</i>	<i>SFFLO</i>	<i>IFFLO</i>	<i>XFFLO</i>
Total Oil Consumption kg	Record	Record	<i>TOTOCON</i>			

TEMPERATURES		SPECIFICATION	AVERAGE	STD. DEV.	MINIMUM	MAXIMUM
Coolant Out	°C	120 ± 2	<i>ACOLOUT</i>	<i>SCOLOUT</i>	<i>ICOLOUT</i>	<i>XCOLOUT</i>
Coolant In	°C	Report Only	<i>ACOLIN</i>	<i>SCOLIN</i>	<i>ICOLIN</i>	<i>XCOLIN</i>
Main Oil Gallery	°C	120 ± 2	<i>AOILTEM</i>	<i>SOILTEM</i>	<i>IOILTEM</i>	<i>XOILTEM</i>
Fuel In	°C	35 ± 2	<i>AFUELIN</i>	<i>SFUELIN</i>	<i>IFUELIN</i>	<i>XFUELIN</i>
Intake Air	°C	32 ± 2	<i>AINAIRT</i>	<i>SINAIRT</i>	<i>IINAIRT</i>	<i>XINAIRT</i>
Oil Sump	°C	Report	<i>ASUMPT</i>	<i>SSUMPT</i>	<i>ISUMPT</i>	<i>XSUMPT</i>
Exhaust	°C	Report	<i>AEXHT</i>	<i>SEXHT</i>	<i>IEXHT</i>	<i>XEXHT</i>

PRESSURES		SPECIFICATION	AVERAGE	STD. DEV.	MINIMUM	MAXIMUM
Crankcase	kPa	Report	<i>ACCASEP</i>	<i>SCCASEP</i>	<i>ICCASEP</i>	<i>XCCASEP</i>
Back Pressure	kPa	103 ± 1	<i>AEXP</i>	<i>SEXP</i>	<i>IEXP</i>	<i>XEXP</i>
Intake Air	kPa	97 ± 1	<i>AINPRES</i>	<i>SINPRES</i>	<i>IINPRES</i>	<i>XINPRES</i>

FIG. A5.17 Operational Summary



D 5966 – 02

ROLLER FOLLOWER WEAR TEST Form 17 - Oil Analysis

Laboratory	<i>LAB</i>	EOT Date	<i>RDTCOMP/DTCOMP</i>
Test Number	<i>STAND - RSTRUN/ISTRUN - ENGINE - RENRUN/ENRUN</i>	Oil Code	<i>OILCODE/CMIR</i>
Formulation/Stand Code	<i>FORM</i>		

Hours	Viscosity, cSt @ 100°C	% SOOT
<i>TST_HNEW</i>	<i>VISIHNEW</i>	<i>TGA_HNEW</i>
<i>TST_H025</i>	<i>VISIH025</i>	<i>TGA_H025</i>
<i>TST_H050</i>	<i>VISIH050</i>	<i>TGA_H050</i>

Hours	Elements						
	Al	Cr	Cu	Fe	Pb	Si	Sn
NEW	<i>AL_HNEW</i>	<i>CR_HNEW</i>	<i>CU_HNEW</i>	<i>FE_HNEW</i>	<i>PB_HNEW</i>	<i>SI_HNEW</i>	<i>SN_HNEW</i>
	<i>AL_H050</i>	<i>CR_H050</i>	<i>CU_H050</i>	<i>FE_H050</i>	<i>PB_H050</i>	<i>SI_H050</i>	<i>SN_H050</i>

FIG. A5.18 Oil Analysis

ASTM D 5966 – 02

Laboratory	<i>LAB</i>	EOT Date	<i>RDTCOMP/DTCOMP</i>
Test Number	<i>STAND - INSTRUMENT - ENGINE - RUN/ENRUN</i>	Oil Code	<i>OILCODE/CMIR</i>
Formulation/Stand Code	<i>FORM</i>		

Number of Downtime Occurrences			DWNOCR
TEST HOURS	DATE	DOWNTIME	REASONS
DOWNH001	DDATH001	DTIMH001	DREAH001
TOTLDOWN			TOTAL DOWNTIME

Other Comments	
Number of Comments	TOTCOM
OCOMH001	

FIG. A5.19 Unscheduled Downtime and Maintenance Summary

 **D 5966 – 02**

Laboratory	<i>LAB</i>	EOT Date	<i>RDTCOMP/DTCOMP</i>
Test Number	<i>STAND - RSTRUN/STRUN - ENGINE - RENRUN/ENRUN</i>	Oil Code	<i>OILCODE/CMIR</i>
Formulation/Stand Code	<i>FORM</i>		

SUPPLIER	<i>FUELSUP</i>	BATCH IDENTIFIERS	<i>FUELBTID</i>
----------	----------------	-------------------	-----------------

Measurement	Specs.	Analysis	Test Method
Total Sulfur, % Weight	0.03 - 0.05	<i>FUELSULF</i>	D 2622
Gravity, °API	32 - 36	<i>APIGRAV</i>	D 287
Hydrocarbon Composition			
Aromatics % Vol.	28 - 35	<i>FUELAROM</i>	D 5186
Olefin	Report	<i>FUELOLEF</i>	D 1319
Saturates	Report	<i>FUELSATU</i>	D 1319
Cetane Index	42 - 48	<i>CETANEIN</i>	D 4737
Cetane No.	42 - 48	<i>CETANENO</i>	D 613
Copper Strip Corrosion	3 Maximum	<i>FUEL CU</i>	D 130
Flash Point, °C	54 Minimum	<i>FLASHPT</i>	D 92
Cloud Point, °C	-12 Maximum	<i>FUEL CLOU</i>	D 2500
Pour Point, °C	-18 Maximum	<i>FUELPOUR</i>	D 97
Carbon Residue on 10% Residium, %	0.35 Maximum	<i>FUEL CRES</i>	D 524 (10 % Bottoms)
Water & Sediment, % Vol	0.05 Maximum	<i>FUEL H2O</i>	D 2709
Ash, % Wgt.	0.01 Maximum	<i>FUELASH</i>	D 482
Viscosity, cSt @ 40°C	2.0 - 3.2	<i>KINVIS</i>	D 445
Distillation, °C			
IBP	177 - 199	<i>FUELIBP</i>	D 86
10%	210 - 232	<i>FUEL10</i>	D 86
50%	249 - 277	<i>FUEL50</i>	D 86
90%	299 - 327	<i>FUEL90</i>	D 86
EP	327 - 360	<i>FUELEP</i>	D 86

FIG. A5.20 Test Fuel Analysis (Last Batch)

Laboratory	<i>LAB</i>	EOT Date	<i>RDTCOMP/DTCOMP</i>
Test Number	<i>STAND - INSTRUMENT/INSTRUM - ENGINE - REV/REV/REV/REV</i>	Oil Code	<i>OILCODE/CMIR</i>
Formulation/Stand Code	<i>FORM</i>		

PARAMETER (1)	SENSING DEVICE (2)	CALIBRATION FREQUENCY (3)	RECORD DEVICE (4)	OBSERVATION FREQUENCY (5)	RECORD FREQUENCY (6)	LOG FREQUENCY (7)	SYSTEM RESPONSE (8)
Temperatures							
MAIN OIL G.	<i>OGTSENS</i>	<i>OGTCALF</i>	<i>OGTREC D</i>	<i>OGTOBSF</i>	<i>OGTREC F</i>	<i>OGTLOG F</i>	
FUEL IN.	<i>FTESENS</i>	<i>FTEMCALF</i>	<i>FTEMREC D</i>	<i>FTEMOBSF</i>	<i>FTEMREC F</i>	<i>FTEML O G F</i>	
INTAKE AIR	<i>AITSENS</i>	<i>AITCALF</i>	<i>AITREC D</i>	<i>AITOBSF</i>	<i>AITREC F</i>	<i>AITLOG F</i>	
OIL SUMP	<i>OSTSENS</i>	<i>OSTCALF</i>	<i>OSTREC D</i>	<i>OSTOBSF</i>	<i>OSTREC F</i>	<i>OSTLOG F</i>	
EXHAUST	<i>EXMWSENS</i>	<i>EXMWCALF</i>	<i>EXMWREC D</i>	<i>EXMWOBSF</i>	<i>EXMWREC F</i>	<i>EXMWLOG F</i>	
COOL. OUT	<i>COTSENS</i>	<i>COTCALF</i>	<i>COTREC D</i>	<i>COTOBSF</i>	<i>COTREC F</i>	<i>COTLOG F</i>	
Other							
FUEL FLOW	<i>FFLOSENS</i>	<i>FFLOCALF</i>	<i>FFLOREC D</i>	<i>FFLOBSF</i>	<i>FFLOREC F</i>	<i>FFLOGLOG F</i>	<i>FFLOSYSR</i>
ENGINE RPM	<i>RPMSSENS</i>	<i>RPMCALF</i>	<i>RPMREC D</i>	<i>RPMOBSF</i>	<i>RPMREC F</i>	<i>RPML O G F</i>	<i>RPMSYSR</i>
LOAD	<i>LOADSENS</i>	<i>LOADCALF</i>	<i>LOADREC D</i>	<i>LOADOBSF</i>	<i>LOADREC F</i>	<i>LOADLOG F</i>	<i>LOADSYSR</i>
INTAKE PRES.	<i>INTVSENS</i>	<i>INTVCALF</i>	<i>INTVREC D</i>	<i>INTVOBSF</i>	<i>INTVREC F</i>	<i>INTVLOG F</i>	<i>INTVSYSR</i>
EXH. PRESS.	<i>EXPRSENS</i>	<i>EXPRCALF</i>	<i>EXPRREC D</i>	<i>EXPROBSF</i>	<i>EXPRREC F</i>	<i>EXPRLOG F</i>	<i>EXPRSYSR</i>
OIL GAL PRES	<i>OILGSENS</i>	<i>OILGCALF</i>	<i>OILGREC D</i>	<i>OILGOBSF</i>	<i>OILGREC F</i>	<i>OILGLOG F</i>	<i>OILGSYSR</i>

LEGEND:

- (1) OPERATING PARAMETER
- (2) THE TYPE OF DEVICE USED TO MEASURE TEMPERATURE, PRESSURE OR FLOW
- (3) FREQUENCY AT WHICH THE MEASUREMENT SYSTEM IS CALIBRATED
- (4) THE TYPE OF DEVICE WHERE DATA IS RECORDED
 LG - HANDLOG SHEET
 DL - AUTOMATIC DATA LOGGER
 SC - STRIP CHART RECORDER
 C/M - COMPUTER, USING MANUAL DATA ENTRY
 C/D - COMPUTER, USING DIRECT I/O ENTRY
- (5) DATA ARE OBSERVED BUT ONLY IF RECORDED OFF SPEC.
- (6) DATA ARE RECORDED BUT ARE NOT RETAINED AT EOT
- (7) DATA ARE LOGGED AS PERMANENT RECORD, NOTE SPECIFY IF:
 SS - SNAPSHOT TAKEN AT SPECIFIED FREQUENCY
 AG/X AVERAGE OF X DATA POINTS AT SPECIFIED FREQUENCY
- (8) TIME FOR THE OUTPUT TO REACH 63.2% OF FINAL VALUE FOR STEP CHANGE AT INPUT

FIG. A5.21 Characteristics of the Data Acquisition System

A6. ILLUSTRATIONS

A6.1 Fig. A6.1 is an illustration of roller follower shaft markings and Fig. A6.2 is a shaft wear depth example.

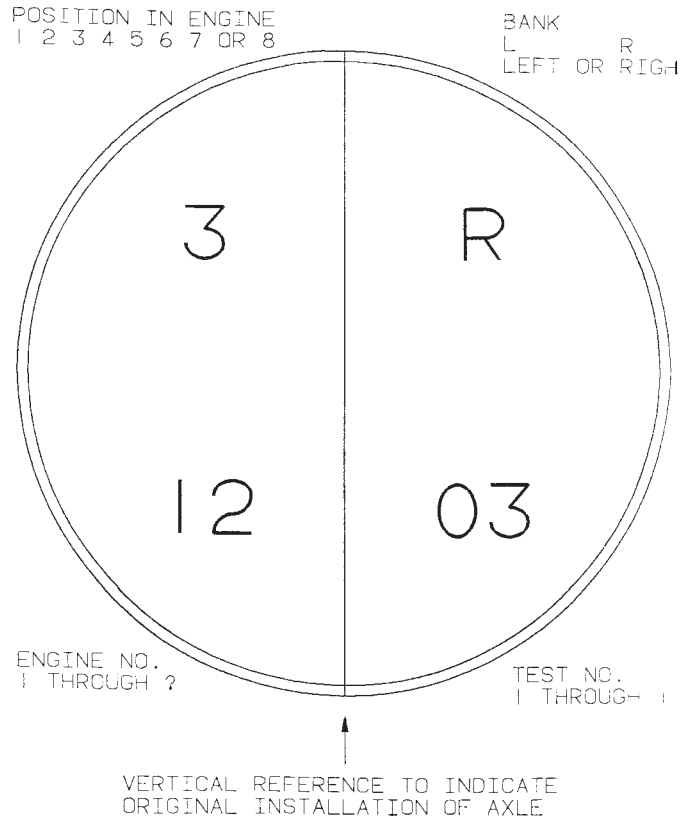
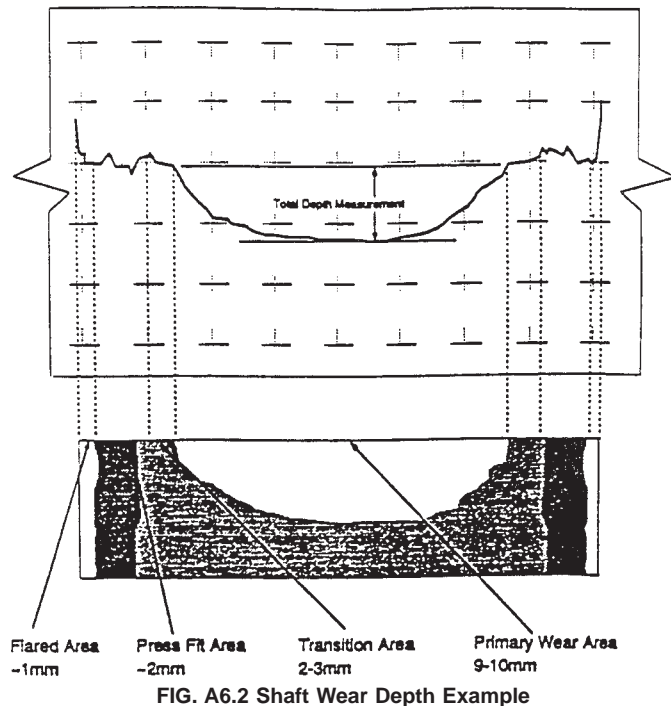

FIG. A6.1 Roller Follower Shaft Markings



A7. KINEMATIC VISCOSITY AT 100°C PROCEDURE FOR THE ROLLER FOLLOWER WEAR TEST

A7.1 This procedure follows Test Method D 445 as stated in the 1994 *Annual Book of ASTM Standards*. There are some modifications and additions.

A7.2 New Oil Samples:

A7.2.1 Use 200 Reverse Flow tube for analyzing all samples.

A7.2.2 Portions of Article 11 of Test Method D 445, follow procedure for Opaque Liquids as outlined here; two tubes, first bulb measurement only.

A7.2.3 Shake all new oil samples using the following procedure. This procedure requires a Red Devil Model 5600 Commercial Paint Shaker or equivalent. Model 5600 subjects the sample to a 497 r/min in a circular motion with a 0.875 in. radius. The springs that hold the machine also provide some up and down motion to the sample. Do not prep more than two samples (four tubes) at the same time.

A7.2.3.1 Be sure cap is tight on sample container.

A7.2.3.2 Place the sample on the paint shaker.

A7.2.3.3 Shake for 5 min.

A7.2.3.4 Remove sample container from paint shaker.

A7.2.3.5 Portions of the sample can now be taken for analysis. No more than 2 min should pass between step A7.2.3.4 and charging of the viscosity tubes.

A7.2.4 Follow step 11.4 of Test Method D 445. As specified, two viscometers should be charged. It is not necessary to heat the sample. Allow the sample to be drawn up to ~1/4-in. past the fill line. See Fig. A7.1.

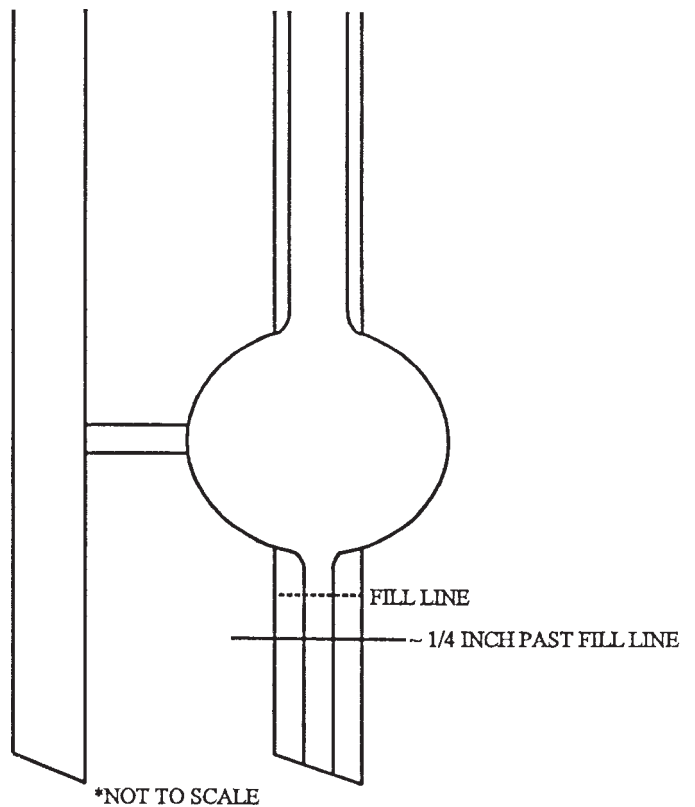

FIG. A7.1 Viscometer Fill Line

A7.2.5 Invert the tube to an upright position and wipe excess sample off of Tube N with a Kimwipe or clean soft cloth.

A7.2.6 Referring to Fig. A7.2, pull a vacuum on Tube L drawing sample to $\sim\frac{3}{4}$ the length of the capillary, Tube R.

A7.2.7 Place stopper on the end of Tube N to prevent the sample from flowing in the tube.

A7.2.7.1 The sample shall not reach the first timing mark E as this will void the test!!

A7.2.8 Follow step 11.4.1 of Test Method D 445. Please note that the viscometer should be mounted upright in the desired bath keeping Tube L vertical. Ensure the bath liquid level is above Bulb D. Use a bath soak time of 15 min \pm 30 s.

A7.2.9 With the sample flowing freely, once the oil comes in contact with the first timing mark E, immediately start the timer. See Fig. A7.3.

A7.2.10 Measure the time required for the oil ring of contact to pass from the first timing mark E to the second timing mark F. As soon as the oil ring of contact reaches F, stop the timer. See Fig. A7.4.

A7.2.11 Finally, follow step 11.6 of Test Method D 445. Report the viscometer results individually and report the average.

A7.3 Used Oil Samples:

A7.3.1 Use a 200 Reverse Flow tube for analyzing all samples. However, if the flow time is greater than 1000 s, use a 300 Reverse Flow tube. For flows exceeding the 1000 s and the centistoke range given for a 300 Reverse Flow Tube, follow what is stated in Fig. A3.2 given in Test Method D 446.

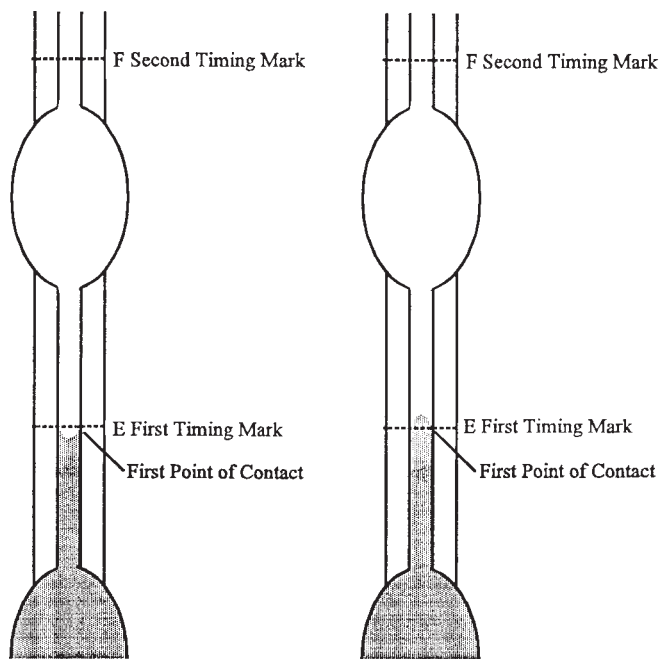

FIG. A7.3 First Timing Mark

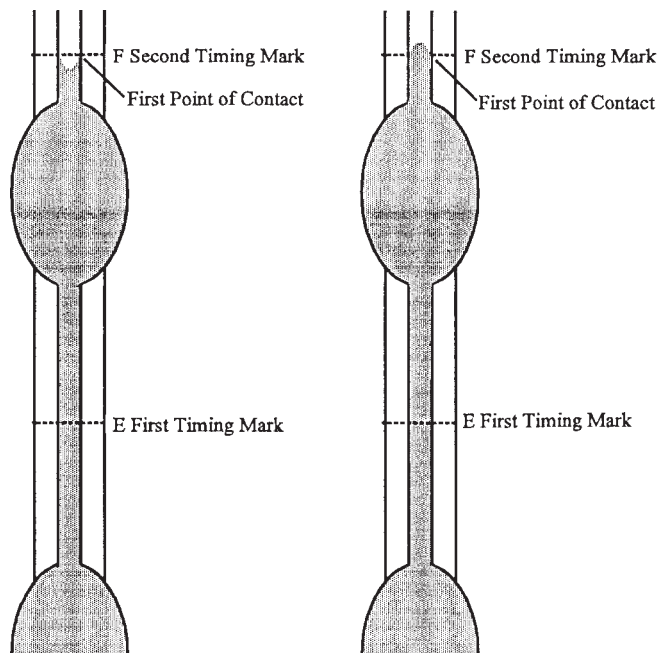

FIG. A7.4 Second Timing Mark

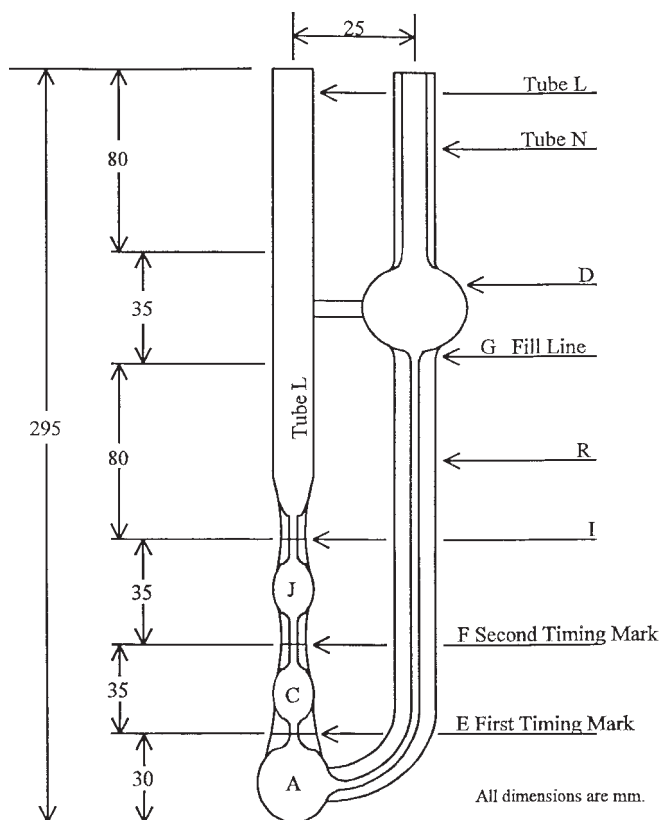

FIG. A7.2 200 Reverse Flow Viscometer

A7.3.2 Portions of Article 11 of Test Method D 445, follow procedure for Opaque Liquids; two tubes, first bulb measurement only. It is not necessary to heat or filter the sample.

A7.3.3 Shake all used oil samples using the following procedure. This procedure requires a Red Devil Model 5600 Commercial Paint Shaker or equivalent. Model 5600 subjects the sample to 497 r/min in a circular motion with a 0.875 in. radius. The springs that hold the machine also provide up and down motion to the sample. Do not prep more than two samples (four tubes) at the same time.

A7.3.3.1 Be sure cap is tight on sample container.

A7.3.3.2 Place the sample on the paint shaker.

A7.3.3.3 Shake for 5 min.

A7.3.3.4 Remove sample container from paint shaker.

A7.3.3.5 Portions of the sample may now be taken for analysis. No more than 2 min should pass between step A7.3.3.4 and the charging of the viscosity tubes.

A7.3.4 Follow step 11.4 of Test Method D 445. As specified, two viscometers should be charged. It is not necessary to heat the sample. Allow the sample to be drawn up to $\sim 1/4$ -in. past the fill line. See Fig. A7.1.

A7.3.5 Invert the tube to an upright position and wipe excess sample off of Tube N with a Kimwipe or clean soft cloth.

A7.3.6 Referring to Fig. A7.2, pull a vacuum on Tube L drawing sample to $\sim 3/4$ the length of the capillary, Tube R.

A7.3.7 Place stopper on the end of Tube N to prevent the sample from flowing in the tube.

A7.3.7.1 The sample shall not reach the first timing mark E as this will void the test!!

A7.3.8 Follow step 11.4.1 of Test Method D 445. Please note that the viscometer should be mounted upright in the desired bath keeping Tube L vertical. Ensure the bath liquid level is above Bulb D. Use a bath soak time of 15 min \pm 30 s.

A7.3.9 With the sample flowing freely, once the oil comes in, contact with the first timing mark E, immediately start the timer. See Fig. A7.3.

A7.3.10 Measure the time required for the oil ring of contact to pass from the first timing mark E to the second timing mark F. As soon as the oil ring of contact reaches F, stop the timer. See Fig. A7.4.

A7.3.11 Finally, follow step 11.6 of Test Method D 445. Report the viscometer results individually and report the average.

A8. ENHANCED THERMAL GRAVIMETRIC ANALYSIS (TGA) PROCEDURE FOR SOOT MEASUREMENT

A8.1 TGA Procedure:

A8.1.1 Be sure cap is tight on sample container.

A8.1.2 Place sample on a commercial paint shaker.

A8.1.3 Shake for 5 min.

A8.1.4 Remove sample container from paint shaker.

A8.1.5 Portions of the sample may now be taken for analysis. No more than 2 min should pass between step A8.1.4 and filling the TGA sample pan.

A8.2 TGA Procedure:

A8.2.1 *Purge Flow Rate*— Use the setting recommended by the TGA instrument manufacturer.

A8.2.1.1 *Nitrogen*—99.99 % minimum purity.

A8.2.1.2 *Oxygen*—99.99 % minimum purity.

A8.2.2 *Sample Size*— 20 mg.

A8.2.3 *Program Steps*:

A8.2.3.1 *Initial Purge Gas*—Nitrogen.

A8.2.3.2 Isothermal at 50°C for 1 min.

A8.2.3.3 Heat to 550°C at 100°C/min.

A8.2.3.4 Isothermal at 550°C for 1 min.

A8.2.3.5 Heat to 650°C at 20°C/min.

A8.2.3.6 Switch gas purge gas to oxygen.

A8.2.3.7 Heat to 750°C at 20°C/min. The program is considered finished once a stable weight residue remains unchanged for 5 min or longer.

A8.2.4 Soot is the difference in weight plateaus at purge gas change, approximately 650°C, and after a stable weight residue is obtained around 750°C. If the actual sample weight is reported, the difference shall be converted to percent of the total. The soot value should be reported to the nearest 0.1 weight %.

A9. SOURCES OF MATERIAL AND INFORMATION

A9.1 Send test engine/stand calibration final reports to the ASTM TMC² and GM Powertrain, Powertrain Headquarters, 895 Joslyn Rd. 1J34, Pontiac, MI 48340-2920.

A9.1.1 Obtain reference oil from the supplier listed below: ASTM TMC.³

A9.1.2 Obtain test fuel from Howell Hydrocarbons Inc., 1201 S. Sheldon Rd., P.O. Box 429, Channelview, TX 77530-0429.

A9.1.3 Obtain test engines, test roller followers, and related components from Bowden Manufacturing Corp., 4590 Beidler Rd., Willoughby, OH 44094.

A10. DATA DICTIONARY

A10.1 Fig. A10.1 presents the roller follower wear test data dictionary. Fig. A10.2 provides the field specifications. When transmitting this Data Dictionary, a Header Data Dictionary should precede the data. The latest version of this Header Data

Dictionary can be obtained from the TMC either by ftp (internet) or by calling the Test Engineer responsible for this particular test.

28-aug-1996

Data Dictionary

<u>Sequence</u>	<u>Form</u>	<u>Test Area</u>	<u>Field Name</u>	<u>Field Length</u>	<u>Decimal Size</u>	<u>Data Type</u>	<u>Units/Format</u>	<u>Description</u>
10	0	RFWT	VERSION	8	0	C	YYYYMMDD	RFWT VERSION 19960828
20	0	RFWT	TSTSPON1	40	0	C		TEST SPONSOR , FIRST LINE
30	0	RFWT	TSTSPON2	40	0	C		TEST SPONSOR, SECOND LINE
40	0	RFWT	LABVALID	1	0	C	V, I OR N	TEST LAB VALIDATION (V, I OR N)
50	0	RFWT	STAND	5	0	C		STAND
60	0	RFWT	RSTRUN	4	0	C		REFERENCE STAND RUN
70	0	RFWT	STRUN	4	0	C		NON-REFERENCE STAND RUN
80	0	RFWT	ENGINE	6	0	C		ENGINE
90	0	RFWT	RENRUN	4	0	C		REFERENCE ENGINE RUN
100	0	RFWT	ENRUN	4	0	C		NON-REFERENCE ENGINE RUN
110	0	RFWT	RDTCOMP	8	0	C	YYYYMMDD	REFERENCE COMPLETED DATE (YYYYMMDD)
120	0	RFWT	DTCOMP	8	0	C	YYYYMMDD	NON-REFERENCE COMPLETED DATE (YYYYMMDD)
130	0	RFWT	REOTIME	5	0	C	HH:MM	REFERENCE COMPLETED TIME (HH:MM)
140	0	RFWT	EOTIME	5	0	C	HH:MM	NON-REFERENCE COMPLETED TIME (HH:MM)
150	0	RFWT	OILCODE	38	0	C		NON-REFERENCE OIL CODE
160	0	RFWT	CMIR	6	0	C		CMIR
170	0	RFWT	FORM	38	0	C		FORMULATION/STAND CODE
180	0	RFWT	ALTCODE1	10	0	C		ALTERNATE OIL CODE 1
190	0	RFWT	ALTCODE2	10	0	C		ALTERNATE OIL CODE 2
200	0	RFWT	ALTCODE3	10	0	C		ALTERNATE OIL CODE 3
210	0	RFWT	SUBLAB	40	0	C		SUBMITTED BY: TESTING LABORATORY
220	0	RFWT	SUBSIGIM	70	0	C		SUBMITTED BY: SIGNATURE IMAGE
230	0	RFWT	SUBNAME	40	0	C		SUBMITTED BY: SIGNATURE TYPED NAME
240	0	RFWT	SUBTITLE	40	0	C		SUBMITTED BY: TITLE
250	1	RFWT	LAB	2	0	C		LAB CODE
260	1	RFWT	RDTSTRT	8	0	C	YYYYMMDD	REFERENCE STARTING DATE (YYYYMMDD)
270	1	RFWT	RTESTLEN	3	0	Z	HHH	REFERENCE TEST LENGTH (HHH)
280	1	RFWT	IND	6	0	C		TMC OIL CODE
290	1	RFWT	RSAEVISC	7	0	C		REFERENCE SAE VISCOSITY GRADE
300	1	RFWT	RLABOCOD	12	0	C		LABORATORY INTERNAL OIL CODE
301	1	RFWT	ENDISPL	4	0	C	L	ENGINE DISPLACEMENT (L)
310	1	RFWT	RWEAR	6	2	N	MILS	REFERENCE AVG WEAR (MILS)
320	1	RFWT	DTSTRT	8	0	C	YYYYMMDD	NON-REFERENCE STARTING DATE (YYYYMMDD)
330	1	RFWT	TESTLEN	3	0	Z	HHH	NON-REFERENCE TEST LENGTH (HHH)
340	1	RFWT	SAEVISC	7	0	C		NON-REFERENCE SAE VISCOSITY GRADE
350	1	RFWT	LABOCODE	12	0	C		LABORATORY INTERNAL OIL CODE
360	1	RFWT	WEAR	6	2	N	MILS	NON-REFERENCE AVG WEAR (MILS)
370	1	RFWT	WEARSA	5	2	N	MILS	NON-REFERENCE WEAR SEVERITY ADJ. (MILS)
380	1	RFWT	AWEARFNL	6	2	N	MILS	NON-REFERENCE AVG ADJUSTED WEAR (MILS)
390	2	RFWT	LIFTPN1	10	0	C		LIFTER PART NUMBER
400	2	RFWT	WEAR1L	6	2	N	MILS	WEAR LIFTER 1L (MILS)
410	2	RFWT	WEAR2L	6	2	N	MILS	WEAR LIFTER 2L (MILS)
420	2	RFWT	WEAR3L	6	2	N	MILS	WEAR LIFTER 3L (MILS)
430	2	RFWT	WEAR4L	6	2	N	MILS	WEAR LIFTER 4L (MILS)
440	2	RFWT	WEAR5L	6	2	N	MILS	WEAR LIFTER 5L (MILS)
450	2	RFWT	WEAR6L	6	2	N	MILS	WEAR LIFTER 6L (MILS)
460	2	RFWT	WEAR7L	6	2	N	MILS	WEAR LIFTER 7L (MILS)
470	2	RFWT	WEAR8L	6	2	N	MILS	WEAR LIFTER 8L (MILS)
480	2	RFWT	WEAR1R	6	2	N	MILS	WEAR LIFTER 1R (MILS)
490	2	RFWT	WEAR2R	6	2	N	MILS	WEAR LIFTER 2R (MILS)
500	2	RFWT	WEAR3R	6	2	N	MILS	WEAR LIFTER 3R (MILS)
510	2	RFWT	WEAR4R	6	2	N	MILS	WEAR LIFTER 4R (MILS)
520	2	RFWT	WEAR5R	6	2	N	MILS	WEAR LIFTER 5R (MILS)

FIG. A10.1 Data Dictionary

28-aug-1996

Report: ASTM Data Dictionary

Sequence	Form	Test Area	Field Name	Field Decimal Data			Units/Format	Description
				Length	Size	Type		
530	2	RFWT	WEAR6R	6	2	N	MILS	WEAR LIFTER 6R (MILS)
540	2	RFWT	WEAR7R	6	2	N	MILS	WEAR LIFTER 7R (MILS)
550	2	RFWT	WEAR8R	6	2	N	MILS	WEAR LIFTER 8R (MILS)
560	2	RFWT	IWEAR	6	2	N	MILS	MINIMUM WEAR STATISTICS (MILS)
570	2	RFWT	XWEAR	6	2	N	MILS	MAXIMUM WEAR STATISTICS (MILS)
580	2	RFWT	SWEAR	6	2	N	MILS	STANDARD DEVIATION WEAR STATISTICS (MILS)
590	3	RFWT	PMRPM	7	1	N	R/MIN	ENGINE SPEED PROCESS MEAN (R/MIN)
600	3	RFWT	PMRPMIM	70	0	C		ENGINE SPEED PROCESS MEAN PLOT IMAGE
610	3	RFWT	PVRPM	5	1	N	R/MIN	ENGINE SPEED PROCESS VARIABILITY (R/MIN)
620	3	RFWT	PVRPMIM	70	0	C		ENGINE SPEED PROCESS VARIABILITY PLOT IMAGE
630	4	RFWT	PMKW	5	1	N	KW	POWER PROCESS MEAN (KW)
640	4	RFWT	PMKWIM	70	0	C		POWER PROCESS MEAN PLOT IMAGE
650	4	RFWT	PVKW	5	1	N	KW	POWER PROCESS VARIABILITY (KW)
660	4	RFWT	PVKWIM	70	0	C		POWER PROCESS VARIABILITY PLOT IMAGE
670	5	RFWT	PMFFLO	4	1	N	KG/H	FUEL FLOW PROCESS MEAN (KG/H)
680	5	RFWT	PMFFLOIM	70	0	C		FUEL FLOW PROCESS MEAN PLOT IMAGE
690	5	RFWT	PVFFLO	4	1	N	KG/H	FUEL FLOW PROCESS VARIABILITY (KG/H)
700	5	RFWT	PVFFLOIM	70	0	C		FUEL FLOW PROCESS VARIABILITY PLOT IMAGE
710	6	RFWT	PMCOLOUT	6	1	N	°C	COOLANT OUT TEMPERATURE PROCESS MEAN (°C)
720	6	RFWT	PMCOLOIM	70	0	C		COOLANT OUT TEMPERATURE PROCESS MEAN PLOT IMAGE
730	6	RFWT	PVCOLOUT	5	1	N	°C	COOLANT OUT TEMPERATURE PROCESS VARIABILITY (°C)
740	6	RFWT	PVCOLOIM	70	0	C		COOLANT OUT TEMPERATURE PROCESS VARIABILITY PLOT IMAGE
750	7	RFWT	PMCOLIN	6	1	N	°C	COOLANT INLET TEMPERATURE PROCESS MEAN (°C)
760	7	RFWT	PMCLINIM	70	0	C		COOLANT INLET TEMPERATURE PROCESS MEAN PLOT IMAGE
770	7	RFWT	PVCOLIN	5	1	N	°C	COOLANT INLET TEMPERATURE PROCESS VARIABILITY (°C)
780	7	RFWT	PVCLINIM	70	0	C		COOLANT INLET TEMPERATURE PROCESS VARIABILITY PLOT IMAGE
790	8	RFWT	PMOILGAL	6	1	N	°C	OIL GALLERY TEMPERATURE PROCESS MEAN (°C)
800	8	RFWT	PMOGALIM	70	0	C		OIL GALLERY TEMPERATURE PROCESS MEAN PLOT IMAGE
810	8	RFWT	PVOILGAL	5	1	N	°C	OIL GALLERY TEMPERATURE PROCESS VARIABILITY (°C)
820	8	RFWT	PVOGALIM	70	0	C		OIL GALLERY TEMPERATURE PROCESS VARIABILITY PLOT IMAGE
830	9	RFWT	PMOILGPR	5	1	N	KPA	OIL GALLERY PRESSURE PROCESS MEAN (KPA)
840	9	RFWT	PMOGPRIM	70	0	C		OIL GALLERY PRESSURE PROCESS MEAN PLOT IMAGE
850	9	RFWT	PVOILGPR	5	1	N	KPA	OIL GALLERY PRESSURE PROCESS VARIABILITY (KPA)
860	9	RFWT	PVOGPRIM	70	0	C		OIL GALLERY PRESSURE PROCESS VARIANCE PLOT IMAGE
870	10	RFWT	PMINAIR	5	1	N	°C	INTAKE AIR TEMPERATURE PROCESS MEAN (°C)
880	10	RFWT	PMIAIRIM	70	0	C		INTAKE AIR TEMPERATURE PROCESS MEAN PLOT IMAGE
890	10	RFWT	PVIAIR	5	1	N	°C	INTAKE AIR TEMPERATURE PROCESS VARIABILITY (°C)
900	10	RFWT	PVIAIRIM	70	0	C		INTAKE AIR TEMPERATURE PROCESS VARIANCE PLOT IMAGE
910	11	RFWT	PMCCPR	4	1	N	KPA	CRANKCASE PRESSURE PROCESS MEAN (KPA)
920	11	RFWT	PMCCPRIM	70	0	C		CRANKCASE PRESSURE PROCESS MEAN PLOT IMAGE
930	11	RFWT	PVCCPR	4	1	N	KPA	CRANKCASE PRESSURE PROCESS VARIABILITY (KPA)
940	11	RFWT	PVCCPRIM	70	0	C		CRANKCASE PRESSURE PROCESS VARIANCE PLOT IMAGE
950	12	RFWT	PMINAIRP	5	1	N	KPA	INTAKE AIR PRESSURE PROCESS MEAN (KPA)
960	12	RFWT	PMIAPIM	70	0	C		INTAKE AIR PRESSURE PROCESS MEAN PLOT IMAGE
970	12	RFWT	PVINAIRP	5	1	N	KPA	INTAKE AIR PRESSURE PROCESS VARIABILITY (KPA)
980	12	RFWT	PVIAPIM	70	0	C		INTAKE AIR PRESSURE PROCESS VARIANCE PLOT IMAGE
990	13	RFWT	PMEXHBP	5	1	N	KPA	EXHAUST BACK PRESSURE PROCESS MEAN (KPA)
1000	13	RFWT	PMEXBPIM	70	0	C		EXHAUST BACK PRESSURE PROCESS MEAN PLOT IMAGE
1010	13	RFWT	PVEXHBP	5	1	N	KPA	EXHAUST BACK PRESSURE PROCESS VARIABILITY (KPA)
1020	13	RFWT	PVEXBPIM	70	0	C		EXHAUST BACK PRESSURE PROCESS VARIANCE PLOT IMAGE
1030	14	RFWT	PMFUELIN	5	1	N	°C	FUEL INTAKE TEMPERATURE PROCESS MEAN (°C)
1040	14	RFWT	PMFUINIM	70	0	C		FUEL INTAKE TEMPERATURE PROCESS MEAN PLOT IMAGE
1050	14	RFWT	PVFUELIN	5	1	N	°C	FUEL INTAKE TEMPERATURE PROCESS VARIABILITY (°C)
1060	14	RFWT	PVFUINIM	70	0	C		FUEL INTAKE TEMPERATURE PROCESS VARIANCE PLOT IMAGE

FIG. A10.1 Data Dictionary (continued)

28-aug-1996

Report: ASTM Data Dictionary

Sequence	Form	Test Area	Field Name	Field Decimal Data			Units/Format	Description
				Length	Size	Type		
1070	15	RFWT	PMEXHT	6	1	N	°C	EXHAUST TEMPERATURE PROCESS MEAN (°C)
1080	15	RFWT	PMEXHTIM	70	0	C		EXHAUST TEMPERATURE PROCESS MEAN PLOT IMAGE
1090	15	RFWT	PVEXHT	6	1	N	°C	EXHAUST TEMPERATURE PROCESS VARIABILITY (°C)
1100	15	RFWT	PVEXHTIM	70	0	C		EXHAUST TEMPERATURE PROCESS VARIANCE PLOT IMAGE
1110	16	RFWT	ARPM	7	1	N	R/MIN	AVG ENGINE SPEED (R/MIN)
1120	16	RFWT	SRPM	5	1	N	R/MIN	STANDARD DEVIATION ENGINE SPEED (R/MIN)
1130	16	RFWT	IRPM	7	1	N	R/MIN	MIN ENGINE SPEED (R/MIN)
1140	16	RFWT	XRPM	7	1	N	R/MIN	MAX ENGINE SPEED (R/MIN)
1150	16	RFWT	ALOAD	6	1	N	NM	AVG LOAD (NM)
1160	16	RFWT	SLOAD	5	1	N	NM	STAND DEV LOAD (NM)
1170	16	RFWT	ILOAD	6	1	N	NM	MIN LOAD (NM)
1180	16	RFWT	XLOAD	6	1	N	NM	MAX LOAD (NM)
1190	16	RFWT	AFFLO	4	1	N	KG/H	AVG FUEL FLOW (KG/H)
1200	16	RFWT	SFFLO	4	1	N	KG/H	STAND DEV FUEL FLOW (KG/H)
1210	16	RFWT	IFFLO	4	1	N	KG/H	MIN FUEL FLOW (KG/H)
1220	16	RFWT	XFFLO	4	1	N	KG/H	MAX FUEL FLOW (KG/H)
1230	16	RFWT	TOTOCON	4	1	N	KG	TOTAL OIL CONSUMPTION (KG)
1240	16	RFWT	ACOLOUT	6	1	N	°C	AVG ENGINE COOLANT OUT TEMPERATURE (°C)
1250	16	RFWT	SCOLOUT	5	1	N	°C	STAND DEV ENGINE COOLANT OUT TEMPERATURE (°C)
1260	16	RFWT	ICOLOUT	6	1	N	°C	MIN ENGINE COOLANT OUT TEMPERATURE (°C)
1270	16	RFWT	XCOLOUT	6	1	N	°C	MAX ENGINE COOLANT OUT TEMPERATURE (°C)
1280	16	RFWT	ACOLIN	6	1	N	°C	AVG ENGINE COOLANT IN TEMPERATURE (°C)
1290	16	RFWT	SCOLIN	5	1	N	°C	STAND DEV ENGINE COOLANT IN TEMPERATURE (°C)
1300	16	RFWT	ICOLIN	6	1	N	°C	MIN ENGINE COOLANT IN TEMPERATURE (°C)
1310	16	RFWT	XCOLIN	6	1	N	°C	MAX ENGINE COOLANT IN TEMPERATURE (°C)
1320	16	RFWT	AOILTEM	6	1	N	°C	AVG MAIN OIL GALLERY TEMPERATURE (°C)
1330	16	RFWT	SOILTEM	5	1	N	°C	STAND DEV MAIN OIL GALLERY TEMPERATURE (°C)
1340	16	RFWT	IOILTEM	6	1	N	°C	MIN MAIN OIL GALLERY TEMPERATURE (°C)
1350	16	RFWT	XOILTEM	6	1	N	°C	MAX MAIN OIL GALLERY TEMPERATURE (°C)
1360	16	RFWT	AFUELIN	5	1	N	°C	AVG FUEL IN TEMPERATURE (°C)
1370	16	RFWT	SFUELIN	5	1	N	°C	STAND DEV FUEL IN TEMPERATURE (°C)
1380	16	RFWT	IFUELIN	5	1	N	°C	MIN FUEL IN TEMPERATURE (°C)
1390	16	RFWT	XFUELIN	5	1	N	°C	MAX FUEL IN TEMPERATURE (°C)
1400	16	RFWT	AINAIRT	5	1	N	°C	AVG INTAKE AIR TEMPERATURE (°C)
1410	16	RFWT	SINAIRT	5	1	N	°C	STAND DEV INTAKE AIR TEMPERATURE (°C)
1420	16	RFWT	IINAIRT	5	1	N	°C	MIN INTAKE AIR TEMPERATURE (°C)
1430	16	RFWT	XINAIRT	5	1	N	°C	MAX INTAKE AIR TEMPERATURE (°C)
1440	16	RFWT	ASUMPT	6	1	N	°C	AVG OIL SUMP TEMPERATURE (°C)
1450	16	RFWT	SSUMPT	5	1	N	°C	STAND DEV OIL SUMP TEMPERATURE (°C)
1460	16	RFWT	ISUMPT	6	1	N	°C	MIN OIL SUMP TEMPERATURE (°C)
1470	16	RFWT	XSUMPT	6	1	N	°C	MAX OIL SUMP TEMPERATURE (°C)
1480	16	RFWT	AEXHT	6	1	N	°C	AVG EXHAUST TEMPERATURE (°C)
1490	16	RFWT	SEXHT	5	1	N	°C	STAND DEV EXHAUST TEMPERATURE (°C)
1500	16	RFWT	IEXHT	6	1	N	°C	MIN EXHAUST TEMPERATURE (°C)
1510	16	RFWT	XEXHT	6	1	N	°C	MAX EXHAUST TEMPERATURE (°C)
1520	16	RFWT	ACCASEP	4	1	N	KPA	AVG CRANKCASE PRESSURE (KPA)
1530	16	RFWT	SCCASEP	4	1	N	KPA	STAND DEV CRANKCASE PRESSURE (KPA)
1540	16	RFWT	ICCASEP	4	1	N	KPA	MIN CRANKCASE PRESSURE (KPA)
1550	16	RFWT	XCCASEP	4	1	N	KPA	MAX CRANKCASE PRESSURE (KPA)
1560	16	RFWT	AEXP	6	1	N	KPA	AVG BACK PRESSURE (KPA)
1570	16	RFWT	SEXP	5	1	N	KPA	STAND DEV BACK PRESSURE (KPA)
1580	16	RFWT	IEXP	6	1	N	KPA	MIN BACK PRESSURE (KPA)
1590	16	RFWT	XEXP	6	1	N	KPA	MAX BACK PRESSURE (KPA)
1600	16	RFWT	AINPRES	5	1	N	KPA	AVG INTAKE AIR PRESSURE (KPA)

FIG. A10.1 Data Dictionary (continued)

28-aug-1996

Report: ASTM Data Dictionary

Sequence	Form	Test Area	Field Name	Field Decimal Data			Units/Format	Description
				Length	Size	Type		
1610	16	RFWT	SINPRES	5	1	N	KPA	STAND DEV INTAKE AIR PRESSURE (KPA)
1620	16	RFWT	IINPRES	5	1	N	KPA	MIN INTAKE AIR PRESSURE (KPA)
1630	16	RFWT	XINPRES	5	1	N	KPA	MAX INTAKE AIR PRESSURE (KPA)
1640	17	RFWT	TST_Hxxx	3	0	C		TEST HOURS
1650	17	RFWT	VISIHxxx	7	2	N	CST	VISCOSITY AT 100 °C AT XXX HOURS (CST)
1670	17	RFWT	TGA_Hxxx	5	1	N	%	PERCENT SOOT AT XXX HOURS (%)
1680	17	RFWT	AL_Hxxx	6	0	N	PPM	ALUMINUM HOURS (PPM)
1690	17	RFWT	CR_Hxxx	6	0	N	PPM	CHROMIUM HOURS (PPM)
1700	17	RFWT	CU_Hxxx	6	0	N	PPM	COPPER HOURS (PPM)
1710	17	RFWT	FE_Hxxx	6	0	N	PPM	IRON HOURS (PPM)
1720	17	RFWT	PB_Hxxx	6	0	N	PPM	LEAD HOURS (PPM)
1730	17	RFWT	SI_Hxxx	6	0	N	PPM	SILICON HOURS (PPM)
1740	17	RFWT	SN_Hxxx	6	0	N	PPM	TIN HOURS (PPM)
1750	18	RFWT	DWNOCR	3	0	Z		NUMBER OF DOWNTIME OCCURRENCES
1760	18	RFWT	DWNHxxx	6	0	C	HHH:MM	DOWNTIME TEST HOURS (HH:MM)
1770	18	RFWT	DDATHxxx	8	0	C	YYYYMMDD	DOWNTIME DATE (YYYYMMDD)
1780	18	RFWT	DTIMHxxx	6	0	C	HHH:MM	DOWNTIME TIME (HH:MM)
1790	18	RFWT	DREAHxxx	60	0	C		DOWNTIME REASON
1800	18	RFWT	TOTLDOWN	6	0	C	HHH:MM	DOWNTIME TIME TOTAL (HHH:MM)
1810	18	RFWT	TOTCOM	2	0	Z		TOTAL LINES OF COMMENTS & OUTLIERS
1820	18	RFWT	OCOMHxxx	70	0	C		TOTAL DOWNTIME COMMENT XXX
1830	19	RFWT	FUELSUP	20	0	C		FUEL SUPPLIER
1840	19	RFWT	FUELBTID	16	0	C		FUEL BATCH IDENTIFIER
1850	19	RFWT	FUELSULF	6	2	N	%	TEST FUEL PERCENT WEIGHT SULFUR (%)
1860	19	RFWT	APIGRAV	4	1	N		TEST FUEL API GRAVITY
1870	19	RFWT	FUELAROM	5	1	N	% VOLUME	TEST FUEL AROMATICS (% VOLUME)
1880	19	RFWT	FUELOLEF	6	1	N		TEST FUEL OLEFIN
1890	19	RFWT	FUELSATU	5	1	N		TEST FUEL SATURATES
1900	19	RFWT	CETANEIN	4	1	N	#	TEST FUEL CETANE INDEX (#)
1910	19	RFWT	CETANENO	4	1	N	#	TEST FUEL CETANE NUMBER (#)
1920	19	RFWT	FUEL CU	5	0	C		TEST FUEL COPPER STRIP CORROSION
1930	19	RFWT	FLASHPT	5	0	N	°C	TEST FUEL FLASH POINT (°C)
1940	19	RFWT	FUEL CLOU	5	0	N	°C	TEST FUEL CLOUD POINT (°C)
1950	19	RFWT	FUELPOUR	6	0	N	°C	TEST FUEL POUR POINT (°C)
1960	19	RFWT	FUEL CRES	6	2	N	%	TEST FUEL CARBON RESIDUE ON 10% RESIDUM (%)
1970	19	RFWT	FUELH2O	7	2	N	% VOLUME	TEST FUEL WATER & SEDIMENT PERCENT (% VOLUME)
1980	19	RFWT	FUELASH	7	3	N	%	TEST FUEL PERCENT WEIGHT ASH (%)
1990	19	RFWT	KINVIS	4	1	N	CST	TEST FUEL KINEMATIC VISCOSITY (CST)
2000	19	RFWT	FUELIBP	6	0	N	°C	TEST FUEL DISTILLATION IBP (°C)
2010	19	RFWT	FUEL10	6	0	N	°C	TEST FUEL DISTILLATION 10% (°C)
2020	19	RFWT	FUEL50	6	0	N	°C	TEST FUEL DISTILLATION 50% (°C)
2030	19	RFWT	FUEL90	6	0	N	°C	TEST FUEL DISTILLATION 90% (°C)
2040	19	RFWT	FUELEP	6	0	N	°C	TEST FUEL DISTILLATION EP (°C)
2050	20	RFWT	OGTSENS	12	0	C		OIL GALLERY TEMPERATURE SENSING DEVICE
2060	20	RFWT	OGTCALF	14	0	C		OIL GALLERY TEMPERATURE CALIBRATION FREQUENCY
2070	20	RFWT	OGTREC D	3	0	C		OIL GALLERY TEMPERATURE RECORD DEVICE
2080	20	RFWT	OGTOBSF	7	0	C		OIL GALLERY TEMPERATURE OBSERVATION FREQUENCY
2090	20	RFWT	OGTREC F	7	0	C		OIL GALLERY TEMPERATURE RECORD FREQUENCY
2100	20	RFWT	OGTLOGF	9	0	C		OIL GALLERY TEMPERATURE LOG FREQUENCY
2110	20	RFWT	FTESENS	12	0	C		FUEL TEMPERATURE SENSING DEVICE
2120	20	RFWT	FTECALF	14	0	C		FUEL TEMPERATURE CALIBRATION FREQUENCY
2130	20	RFWT	FTEMREC D	3	0	C		FUEL TEMPERATURE RECORD DEVICE
2140	20	RFWT	FTEMOBSF	7	0	C		FUEL TEMPERATURE OBSERVATION FREQUENCY
2150	20	RFWT	FTEMREC F	7	0	C		FUEL TEMPERATURE RECORD FREQUENCY

FIG. A10.1 Data Dictionary (continued)

28-aug-1996

Report: ASTM Data Dictionary

Sequence	Form	Test Area	Field Name	Field Length	Decimal Size	Data Type	Units/Format	Description
2160	20	RFWT	FTEMLOGF	9	0	C		FUEL TEMPERATURE LOG FREQUENCY
2170	20	RFWT	AITSENS	12	0	C		AIR IN TEMPERATURE SENSING DEVICE
2180	20	RFWT	AITCALF	14	0	C		AIR IN TEMPERATURE CALIBRATION FREQUENCY
2190	20	RFWT	AITRECD	3	0	C		AIR IN TEMPERATURE RECORD DEVICE
2200	20	RFWT	AITOBSF	7	0	C		AIR IN TEMPERATURE OBSERVATION FREQUENCY
2210	20	RFWT	AITRECF	7	0	C		AIR IN TEMPERATURE RECORD FREQUENCY
2220	20	RFWT	AITLOGF	9	0	C		AIR IN TEMPERATURE LOG FREQUENCY
2230	20	RFWT	OSTSENS	12	0	C		OIL SUMP TEMPERATURE SENSING DEVICE
2240	20	RFWT	OSTCALF	14	0	C		OIL SUMP TEMPERATURE CALIBRATION FREQUENCY
2250	20	RFWT	OSTRECD	3	0	C		OIL SUMP TEMPERATURE RECORD DEVICE
2260	20	RFWT	OSTOBSF	7	0	C		OIL SUMP TEMPERATURE OBSERVATION FREQUENCY
2270	20	RFWT	OSTRECF	7	0	C		OIL SUMP TEMPERATURE RECORD FREQUENCY
2280	20	RFWT	OSTLOGF	9	0	C		OIL SUMP TEMPERATURE LOG FREQUENCY
2290	20	RFWT	EXMWSENS	12	0	C		EXHAUST MANIFOLD WATER COOLANT OUTLET SENSING DEVICE
2300	20	RFWT	EXMWCALF	14	0	C		EXHAUST MANIFOLD WATER COOLANT OUTLET CALIBRATION FREQUENCY
2310	20	RFWT	EXMWRECD	3	0	C		EXHAUST MANIFOLD WATER COOLANT OUTLET RECORD DEVICE
2320	20	RFWT	EXMWOBSF	7	0	C		EXHAUST MANIFOLD WATER COOLANT OUTLET OBSERVATION FREQUENCY
2330	20	RFWT	EXMWRECF	7	0	C		EXHAUST MANIFOLD WATER COOLANT OUTLET RECORD FREQUENCY
2340	20	RFWT	EXMWLOGF	9	0	C		EXHAUST MANIFOLD WATER COOLANT OUTLET LOG FREQUENCY
2350	20	RFWT	COTSENS	12	0	C		COOLANT OUT TEMPERATURE SENSING DEVICE
2360	20	RFWT	COTCALF	14	0	C		COOLANT OUT TEMPERATURE CALIBRATION FREQUENCY
2370	20	RFWT	COTRECD	3	0	C		COOLANT OUT TEMPERATURE RECORD DEVICE
2380	20	RFWT	COTOBSF	7	0	C		COOLANT OUT TEMPERATURE OBSERVATION FREQUENCY
2390	20	RFWT	COTRECF	7	0	C		COOLANT OUT TEMPERATURE RECORD FREQUENCY
2400	20	RFWT	COTLOGF	9	0	C		COOLANT OUT TEMPERATURE LOG FREQUENCY
2410	20	RFWT	FFLOSENS	12	0	C		FUEL FLOW SENSING DEVICE
2420	20	RFWT	FFLOCALF	14	0	C		FUEL FLOW CALIBRATION FREQUENCY
2430	20	RFWT	FFLORECD	3	0	C		FUEL FLOW RECORD DEVICE
2440	20	RFWT	FFLOOBSF	7	0	C		FUEL FLOW OBSERVATION FREQUENCY
2450	20	RFWT	FFLORECF	7	0	C		FUEL FLOW RECORD FREQUENCY
2460	20	RFWT	FFLOLOGF	9	0	C		FUEL FLOW LOG FREQUENCY
2470	20	RFWT	FFLOSYSR	8	0	C		FUEL FLOW SYSTEM RESPONSE
2480	20	RFWT	RPMSSENS	12	0	C		ENGINE SPEED SENSING DEVICE
2490	20	RFWT	RPMCALF	14	0	C		ENGINE SPEED CALIBRATION FREQUENCY
2500	20	RFWT	RPMRECD	3	0	C		ENGINE SPEED RECORD DEVICE
2510	20	RFWT	RPMOBSF	7	0	C		ENGINE SPEED OBSERVATION FREQUENCY
2520	20	RFWT	RPMRECF	7	0	C		ENGINE SPEED RECORD FREQUENCY
2530	20	RFWT	RPMLOGF	9	0	C		ENGINE SPEED LOG FREQUENCY
2540	20	RFWT	RPMSYSR	8	0	C		ENGINE SPEED SYSTEM RESPONSE
2550	20	RFWT	LOADSENS	12	0	C		LOAD SENSING DEVICE
2560	20	RFWT	LOADCALF	14	0	C		LOAD CALIBRATION FREQUENCY
2570	20	RFWT	LOADRECD	3	0	C		LOAD RECORD DEVICE
2580	20	RFWT	LOADOBSF	7	0	C		LOAD OBSERVATION FREQUENCY
2590	20	RFWT	LOADRECF	7	0	C		LOAD RECORD FREQUENCY
2600	20	RFWT	LOADLOGF	9	0	C		LOAD LOG FREQUENCY
2610	20	RFWT	LOADSYSR	8	0	C		LOAD SYSTEM RESPONSE
2620	20	RFWT	INTVSENS	12	0	C		INTAKE VACUUM SENSING DEVICE
2630	20	RFWT	INTVCALF	14	0	C		INTAKE VACUUM CALIBRATION FREQUENCY
2640	20	RFWT	INTVRECD	3	0	C		INTAKE VACUUM RECORD DEVICE
2650	20	RFWT	INTVOBSF	7	0	C		INTAKE VACUUM OBSERVATION FREQUENCY
2660	20	RFWT	INTVRECF	7	0	C		INTAKE VACUUM RECORD FREQUENCY
2670	20	RFWT	INTVLOGF	9	0	C		INTAKE VACUUM LOG FREQUENCY
2680	20	RFWT	INTVSYSR	8	0	C		INTAKE VACUUM SYSTEM RESPONSE
2690	20	RFWT	EXPRSENS	12	0	C		EXHAUST PRESSURE SENSING DEVICE

FIG. A10.1 Data Dictionary (continued)



28-aug-1996

Report: ASTM Data Dictionary

<u>Sequence</u>	<u>Form</u>	<u>Test Area</u>	<u>Field Name</u>	<u>Field Length</u>	<u>Decimal Size</u>	<u>Data Type</u>	<u>Units/Format</u>	<u>Description</u>
2700	20	RFWT	EXPRCALF	14	0	C		EXHAUST PRESSURE CALIBRATION FREQUENCY
2710	20	RFWT	EXPRECD	3	0	C		EXHAUST PRESSURE RECORD DEVICE
2720	20	RFWT	EXPROBSF	7	0	C		EXHAUST PRESSURE OBSERVATION FREQUENCY
2730	20	RFWT	EXPRECF	7	0	C		EXHAUST PRESSURE RECORD FREQUENCY
2740	20	RFWT	EXPRLOGF	9	0	C		EXHAUST PRESSURE LOG FREQUENCY
2750	20	RFWT	EXPRYSR	8	0	C		EXHAUST PRESSURE SYSTEM RESPONSE
2760	20	RFWT	OILGSENS	12	0	C		OIL GALLERY PRESSURE SENSING DEVICE
2770	20	RFWT	OILGCALF	14	0	C		OIL GALLERY PRESSURE CALIBRATION FREQUENCY
2780	20	RFWT	OILGRECD	3	0	C		OIL GALLERY PRESSURE RECORD DEVICE
2790	20	RFWT	OILGOBSF	7	0	C		OIL GALLERY PRESSURE OBSERVATION FREQUENCY
2800	20	RFWT	OILGRECF	7	0	C		OIL GALLERY PRESSURE RECORD FREQUENCY
2810	20	RFWT	OILGLOGF	9	0	C		OIL GALLERY PRESSURE LOG FREQUENCY
2820	20	RFWT	OILGSYSR	8	0	C		OIL GALLERY PRESSURE SYSTEM RESPONSE

FIG. A10.1 Data Dictionary (continued)

```
#####
#
#           R e p e a t i n g   F i e l d   S p e c i f i c a t i o n s   #
#
#####
# This file contains specifications and field groupings for fields in the
# Data Dictionary that are REPEATING Fields.  These fields can be identified
# in the Data Dictionary by the Hxxx or Rxxx in the last four positions of the
# field name.
#
# Repeating fields are used to specify repeating measurements.
#
# The format for a repeating field name is 4 descriptive characters followed
# by the letter H or R followed by 3 characters for the actual interval
# the measurement was taken. The field will always be a total of 8 characters.
#
# Example ABCDHxxx.
#
# The following is the format of this file:
#
# Column 1 - 8:   Repeating Field Name
# Column 10 - 17: The Parent Field Name of the Group
# Column 19 - 80: Comments about the Repeating Field Group.
#
# The lines following the Repeating Field Name Record will contain the required
# measurements for the particular field.  Multiple 80 character lines
# can be specified.  A blank line marks the end of each specification.
#
# The Field Name in Column 10-17 designates the the Group in which the field
# belongs.  The First field name in a group is the Parent of the grouping
# and can be used to determine how fields should be grouped.
# The changing of the Parent Field marks the end of a repeating group
# specification.
#
# Example:
#
# VIS_Hxxx, DVISHxxx and PVISHxxx expanded for transmission (8 and 16 hours):
#
#           VIS_H008
#           DVISH008
#           PVISH008
#           VIS_H016
#           DVISH016
#           PVISH016
#
# Note:  Repeating field groups must be kept together with in the specified
#        group but the order with in the group does not have to be maintained.
#
#####
#           S t a r t   o f   F i e l d   G r o u p i n g   S p e c i f i c a t i o n s   #
#####
#
RFWT VERSION 19960828
TST_Hxxx TST_Hxxx   TEST HOURS
025 050 NEW

VIS1Hxxx TST_Hxxx   VISCOSITY AT 100 DEG C AT XXX HOURS (CST)
025 050 NEW

TGA_Hxxx TST_Hxxx   PERCENT SOOT AT XXX HOURS (%)

```

FIG. A10.2 Field Specifications

025 050 NEW

AL__Hxxx AG__Hxxx ALUMINUM HOURS (PPM)
050 NEW

CR__Hxxx AG__Hxxx CHROMIUM HOURS (PPM)
050 NEW

CU__Hxxx AG__Hxxx COPPER HOURS (PPM)
050 NEW

FE__Hxxx AG__Hxxx IRON HOURS (PPM)
050 NEW

PB__Hxxx AG__Hxxx LEAD HOURS (PPM)
050 NEW

SI__Hxxx AG__Hxxx SILICON HOURS (PPM)
050 NEW

SN__Hxxx AG__Hxxx TIN HOURS (PPM)
050 NEW

DOWNHxxx DOWNHxxx DOWNTIME TEST HOURS (HH:MM)

DDATHxxx DOWNHxxx DOWNTIME DATE (YYYYMMDD)

DTIMHxxx DOWNHxxx DOWNTIME TIME (HH:MM)

DREAHxxx DOWNHxxx DOWNTIME REASON

OCOMHxxx OCOMHxxx TOTAL DOWNTIME COMMENT XXX

FIG. A10.2 Field Specifications (continued)

```
*****
*
* When transmitting this Data Dictionary, a Header Data Dictionary should
* precede the data. The latest version of this Header Data Dictionary can
* be obtained from the Test Monitoring Center either by ftp (internet) or
* by calling the Test Engineer responsible for this particular test.
*
*****
FIG. A10.2 Field Specifications (continued)
```

APPENDIXES

(Nonmandatory Information)

X1. RANGES FOR HOWELL LSRD-4 REFERENCE FUEL

X1.1 The ranges for Howell LSRD-4 reference fuel are provided in Table X1.1.

TABLE X1.1 Ranges for Howell LSRD-4 Reference Fuel

Howell Hydrocarbons LSRD-4 Fuel	
Parameter	Specification
Distillation	
Initial boiling point, °C	177–199
10 %	210–232
50 %	249–277
90 %	299–327
End point	327–360
Gravity, API	32.0–36.0
Cetane number	42.0–48.0
Cetane index	42.0–48.0
Flash point, °C	54 min
Cloud point, °C	–12 max
Pour point, °C	–17 max
Sulfur, wt %	0.03–0.05
Viscosity, cSt at 40°C	2.0–3.2
Hydrocarbon composition, wt %	
Aromatics	27.0–35.0
Olefins	Report
Saturates	Report
Copper corrosion at 100°C	3 max
Ash, wt %	0.01 max
Ramsbottom carbon residue, 10 % residum	0.15 max

X2. DIAGNOSTIC DATA REVIEW

X2.1 This section outlines significant characteristics of specific engine operating parameters. The parameters may directly influence the test or may be used to indicate normalcy of other parameters.

X2.1.1 *Fuel Consumption Rate/Engine Speed/Engine Load/Injection Timing*—All four parameters can affect soot generation.

X2.1.2 *Crankcase Pressure*—Crankcase pressure is a function of blowby flow rate and is normally slightly above atmospheric pressure.

X2.1.3 *Oil Pressure*— Oil pressure increases throughout the test because of increased soot loading.

X2.1.4 *Oil Temperature Differential*—The oil temperature differential is primarily a function of heat rejection to the oil, oil flow rate, and oil viscosity and is normally stable throughout the test.

X2.1.5 *Coolant Temperature Differential*—The coolant temperature differential is primarily a function of coolant flow rate and heat rejection to the coolant and is normally stable throughout the test. Large variations in the differential may be caused by coolant flow rate or temperature measurement errors. Coolant flow rate measurement errors can be caused by foreign objects in or near the venturi flow meter.

ASTM International takes no position respecting the validity of any patent rights asserted in connection with any item mentioned in this standard. Users of this standard are expressly advised that determination of the validity of any such patent rights, and the risk of infringement of such rights, are entirely their own responsibility.

This standard is subject to revision at any time by the responsible technical committee and must be reviewed every five years and if not revised, either reapproved or withdrawn. Your comments are invited either for revision of this standard or for additional standards and should be addressed to ASTM International Headquarters. Your comments will receive careful consideration at a meeting of the responsible technical committee, which you may attend. If you feel that your comments have not received a fair hearing you should make your views known to the ASTM Committee on Standards, at the address shown below.

This standard is copyrighted by ASTM International, 100 Barr Harbor Drive, PO Box C700, West Conshohocken, PA 19428-2959, United States. Individual reprints (single or multiple copies) of this standard may be obtained by contacting ASTM at the above address or at 610-832-9585 (phone), 610-832-9555 (fax), or service@astm.org (e-mail); or through the ASTM website (www.astm.org).