



# Standard Test Method for Cavitation Erosion Using Vibratory Apparatus<sup>1</sup>

This standard is issued under the fixed designation G 32; the number immediately following the designation indicates the year of original adoption or, in the case of revision, the year of last revision. A number in parentheses indicates the year of last reapproval. A superscript epsilon ( $\epsilon$ ) indicates an editorial change since the last revision or reapproval.

## 1. Scope

1.1 This test method produces cavitation damage on the face of a specimen vibrated at high frequency while immersed in a liquid. The vibration induces the formation and collapse of cavities in the liquid, and the collapsing cavities produce the damage to and erosion (material loss) of the specimen.

1.2 Although the mechanism for generating fluid cavitation in this method differs from that occurring in flowing systems and hydraulic machines (see 5.1), the nature of the material damage mechanism is believed to be basically similar. The method therefore offers a small-scale, relatively simple and controllable test that can be used to compare the cavitation erosion resistance of different materials, to study in detail the nature and progress of damage in a given material, or—by varying some of the test conditions—to study the effect of test variables on the damage produced.

1.3 This test method specifies standard test conditions covering the diameter, vibratory amplitude and frequency of the specimen, as well as the test liquid and its container. It permits deviations from some of these conditions if properly documented, that may be appropriate for some purposes. It gives guidance on setting up a suitable apparatus and covers test and reporting procedures and precautions to be taken. It also specifies standard reference materials that must be used to verify the operation of the facility and to define the normalized erosion resistance of other test materials.

1.4 The values stated in SI units are to be regarded as standard. The inch-pound units given in parentheses are for information only.

1.5 *This standard does not purport to address all of the safety concerns, if any, associated with its use. It is the responsibility of the user of this standard to establish appropriate safety and health practices and determine the applicability of regulatory limitations prior to use.* For specific safety precautionary information, see 6.1, 10.3, and 10.6.

## 2. Referenced Documents

### 2.1 ASTM Standards:

- A 276 Specification for Stainless Steel Bars and Shapes<sup>2</sup>
- B 160 Specification for Nickel Rod and Bar<sup>3</sup>
- B 211 Specification for Aluminum and Aluminum-Alloy Bar, Rod, and Wire<sup>4</sup>
- D 1193 Specification for Reagent Water<sup>5</sup>
- E 177 Practice for Use of the Terms Precision and Bias in ASTM Test Methods<sup>6</sup>
- E 691 Practice for Conducting an Interlaboratory Study to Determine the Precision of a Test Method<sup>6</sup>
- E 960 Specification for Laboratory Glass Beakers<sup>7</sup>
- G 40 Terminology Relating to Wear and Erosion<sup>8</sup>
- G 73 Practice for Liquid Impingement Erosion Testing<sup>8</sup>
- G 134 Test Method for Erosion of Solid Materials by a Cavitating Liquid Jet<sup>8</sup>

## 3. Terminology

### 3.1 Definitions:

3.1.1 See Terminology G 40 for definitions of terms relating to cavitation erosion. For convenience, definitions of some important terms used in this test method are quoted below from Terminology G 40 – 98.

3.1.2 *average erosion rate, n*—a less preferred term for cumulative erosion rate.

3.1.3 *cavitation, n*—the formation and subsequent collapse, within a liquid, of cavities or bubbles that contain vapor or gas, or both.

3.1.3.1 *Discussion*—In general, cavitation originates from a local decrease in hydrostatic pressure in the liquid, produced by motion of the liquid (see *flow cavitation*) or of a solid boundary (see *vibratory cavitation*). It is distinguished in this way from boiling, which originates from an increase in liquid temperature.

<sup>2</sup> Annual Book of ASTM Standards, Vol 01.03.

<sup>3</sup> Annual Book of ASTM Standards, Vol 02.04.

<sup>4</sup> Annual Book of ASTM Standards, Vol 02.02.

<sup>5</sup> Annual Book of ASTM Standards, Vol 11.01.

<sup>6</sup> Annual Book of ASTM Standards, Vol 14.02.

<sup>7</sup> Annual Book of ASTM Standards, Vol 14.04.

<sup>8</sup> Annual Book of ASTM Standards, Vol 03.02.

<sup>1</sup> This test method is under the jurisdiction of ASTM Committee G02 on Wear and Erosion and is the direct responsibility of Subcommittee G02.10 on Erosion by Liquids and Solids.

Current edition approved April 10, 2003. Published May 2003. Originally approved in 1972. Last previous edition approved in 1998 as G 32 – 98.

3.1.3.2 *Discussion*—The term cavitation, by itself, should not be used to denote the damage or erosion of a solid surface that can be caused by it; this effect of cavitation is termed *cavitation damage* or *cavitation erosion*. To erode a solid surface, bubbles or cavities must collapse on or near that surface.

3.1.4 *cavitation erosion, n*—progressive loss of original material from a solid surface due to continued exposure to cavitation.

3.1.5 *cumulative erosion, n*—the total amount of material lost from a solid surface during all exposure periods since it was first exposed to cavitation or impingement as a newly finished surface. (More specific terms that may be used are *cumulative mass loss*, *cumulative volume loss*, or *cumulative mean depth of erosion*. See also *cumulative erosion-time curve*.)

3.1.5.1 *Discussion*—Unless otherwise indicated by the context, it is implied that the conditions of cavitation or impingement have remained the same throughout all exposure periods, with no intermediate refinishing of the surface.

3.1.6 *cumulative erosion rate, n*—the cumulative erosion at a specified point in an erosion test divided by the corresponding cumulative exposure duration; that is, the slope of a line from the origin to the specified point on the cumulative erosion-time curve. (*Synonym: average erosion rate*)

3.1.7 *cumulative erosion-time curve*—a plot of cumulative erosion versus cumulative exposure duration, usually determined by periodic interruption of the test and weighing of the specimen. This is the primary record of an erosion test. Most other characteristics, such as the incubation period, maximum erosion rate, terminal erosion rate, and erosion rate-time curve, are derived from it.

3.1.8 *erosion rate-time curve, n*—a plot of instantaneous erosion rate versus exposure duration, usually obtained by numerical or graphical differentiation of the cumulative erosion-time curve. (See also *erosion rate-time pattern*.)

3.1.9 *erosion rate-time pattern, n*—any qualitative description of the shape of the erosion rate-time curve in terms of the several stages of which it may be composed.

3.1.9.1 *Discussion*—In cavitation and liquid impingement erosion, a typical pattern may be composed of all or some of the following “periods” or “stages”: *incubation period*, *acceleration period*, *maximum-rate period*, *deceleration period*, *terminal period*, and occasionally *catastrophic period*. The generic term “period” is recommended when associated with quantitative measures of its duration, etc.; for purely qualitative descriptions the term “stage” is preferred.

3.1.10 *incubation period, n*—the initial stage of the erosion rate-time pattern during which the erosion rate is zero or negligible compared to later stages. Also, the exposure duration associated with this stage. (Quantitatively it is sometimes defined as the intercept on the time or exposure axis, of a straight line extension of the maximum-slope portion of the cumulative erosion-time curve.)

3.1.11 *maximum erosion rate, n*—the maximum instantaneous erosion rate in a test that exhibits such a maximum followed by decreasing erosion rates. (See also *erosion rate-time pattern*.)

3.1.11.1 *Discussion*—Occurrence of such a maximum is typical of many cavitation and liquid impingement tests. In some instances it occurs as an instantaneous maximum, in others as a steady-state maximum which persists for some time.

3.1.12 *mean depth of erosion (MDE), n*—the average thickness of material eroded from a specified surface area, usually calculated by dividing the measured mass loss by the density of the material to obtain the volume loss and dividing that by the area of the specified surface. (Also known as *mean depth of penetration* or *MDP*. Since that might be taken to denote the average value of the depths of individual pits, it is a less preferred term.)

3.1.13 *normalized erosion resistance,  $N_e$ , n*—the volume loss rate of a test material, divided into the volume loss rate of a specified reference material similarly tested and similarly analyzed. By “similarly analyzed” is meant that the two erosion rates must be determined for corresponding portions of the erosion rate time pattern; for instance, the maximum erosion rate or the terminal erosion rate.

3.1.13.1 *Discussion*—A recommended complete wording has the form, “The normalized erosion resistance of (test material) relative to (reference material) based on (criterion of data analysis) is (numerical value).”

3.1.14 *normalized incubation resistance  $N_o$ , n*—the incubation period of a test material, divided by the incubation period of a specified reference material similarly tested and similarly analyzed. (See also *normalized erosion resistance*.)

3.1.15 *tangent erosion rate*—the slope of a straight line drawn through the origin and tangent to the knee of the cumulative erosion-time curve, when that curve has the characteristic S-shaped pattern that permits this. In such cases, the tangent erosion rate also represents the maximum cumulative erosion rate exhibited during the test.

3.1.16 *terminal erosion rate, n*—the final steady-state erosion rate that is reached (or appears to be approached asymptotically) after the erosion rate has declined from its maximum value. (See also *terminal period* and *erosion rate-time pattern*.)

3.1.17 *vibratory cavitation, n*—cavitation caused by the pressure fluctuations within a liquid, induced by the vibration of a solid surface immersed in the liquid.

## 4. Summary of Test Method

4.1 This test method generally utilizes a commercially obtained 20-kHz ultrasonic transducer to which is attached a suitably designed “horn” or velocity transformer. A specimen button of proper mass is attached by threading into the tip of the horn.

4.2 The specimen is immersed into a container of the test liquid (generally distilled water) that must be maintained at a specified temperature during test operation, while the specimen is vibrated at a specified amplitude. The amplitude and frequency of vibration of the test specimen must be accurately controlled and monitored.

4.3 The test specimen is weighed accurately before testing begins and again during periodic interruptions of the test, in order to obtain a history of mass loss versus time (which is not

linear). Appropriate interpretation of this cumulative erosion-versus-time curve permits comparison of results between different materials or between different test fluids or other conditions.

## 5. Significance and Use

5.1 This test method may be used to estimate the relative resistance of materials to cavitation erosion as may be encountered, for instance, in pumps, hydraulic turbines, hydraulic dynamometers, valves, bearings, diesel engine cylinder liners, ship propellers, hydrofoils, and in internal flow passages with obstructions. An alternative method for similar purposes is Test Method G 134, which employs a cavitating liquid jet to produce erosion on a stationary specimen. The latter may be more suitable for materials not readily formed into a precisely shaped specimen. The results of either, or *any*, cavitation erosion test should be used with caution; see 5.7.

5.2 Some investigators have also used this test method as a screening test for materials subjected to liquid impingement erosion as encountered, for instance, in low-pressure steam turbines and in aircraft, missiles or spacecraft flying through rainstorms. Practice G 73 describes another testing approach specifically intended for that type of environment.

5.3 This test method is not recommended for evaluating elastomeric or compliant coatings, some of which have been successfully used for protection against cavitation or liquid impingement of moderate intensity. This is because the compliance of the coating on the specimen may reduce the severity of the liquid cavitation induced by its vibratory motion. The result would not be representative of a field application, where the hydrodynamic generation of cavitation is independent of the coating.

NOTE 1—An alternative approach that uses the same basic apparatus, and is deemed suitable for compliant coatings, is the “stationary specimen” method. In that method, the specimen is fixed within the liquid container, and the vibrating tip of the horn is placed in close proximity to it. The cavitation “bubbles” induced by the horn (usually fitted with a highly resistant replaceable tip) act on the specimen. While several investigators have used this approach (see X3.2.3), they have differed with regard to standoff distances and other arrangements. The stationary specimen approach can also be used for brittle materials which can not be formed into a threaded specimen nor into a disc that can be cemented to a threaded specimen, as required for this test method (see 7.6).

5.4 This test method should not be directly used to rank materials for applications where electrochemical corrosion or solid particle impingement plays a major role. However, adaptations of the basic method and apparatus have been used for such purposes (see 9.2.5, X3.2).

5.5 Those who are engaged in basic research, or concerned with very specialized applications, may need to vary some of the test parameters to suit their purposes. However, adherence to this test method in all other respects will permit a better understanding and correlation between the results of different investigators.

5.6 Because of the nonlinear nature of the erosion-versus-time curve in cavitation and liquid impingement erosion, the shape of that curve must be considered in making comparisons and drawing conclusions. See Section 11.

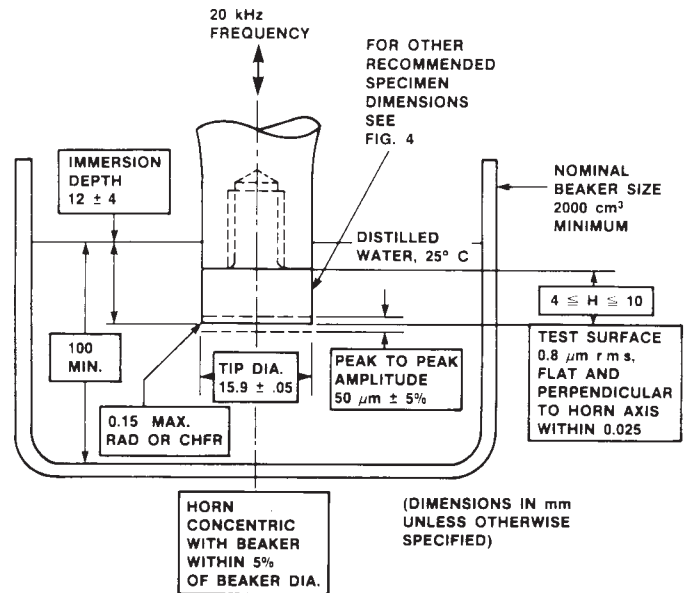

FIG. 1 Important Parameters of the Vibratory Cavitation Test

5.7 The mechanisms of cavitation erosion and liquid impingement erosion are not fully understood and may differ, depending on the detailed nature, scale, and intensity of the liquid/solid interactions. “Erosion resistance” may, therefore, represent a mix of properties rather than a single property, and has not yet been successfully correlated with other independently measurable material properties. For this reason, the consistency of results between different test methods or under different field conditions is not very good. Small differences between two materials are probably not significant, and their relative ranking could well be reversed in another test.

## 6. Apparatus

6.1 The vibratory apparatus used for this test method produces axial oscillations of a test specimen inserted to a specified depth in the test liquid. The vibrations are generated by a magnetostrictive or piezoelectric transducer, driven by a suitable electronic oscillator and power amplifier. The power of the system should be sufficient to permit constant amplitude of the specimen in air as well as submerged. An acoustic power output of 250 to 1000 W has been found suitable. Such systems are commercially available, intended for ultrasonic welding, emulsifying, and so forth.<sup>9</sup> (**Warning**—This apparatus may generate high sound levels. The use of ear protection may be necessary. Provision of an acoustical enclosure is recommended.)

6.1.1 The basic parameters involved in this test method are pictorially shown in Fig. 1. Schematic and photographic views of representative equipment are shown in Figs. 2 and 3 respectively.

<sup>9</sup> Several manufacturers of ultrasonic processing or plastics welding equipment offer apparatus off-the-shelf, or specially modified, to meet the specifications given in this standard. A list of those known to the subcommittee having jurisdiction is available from its chairman. Inclusion in this list does not imply such equipment has been qualified in a test program.

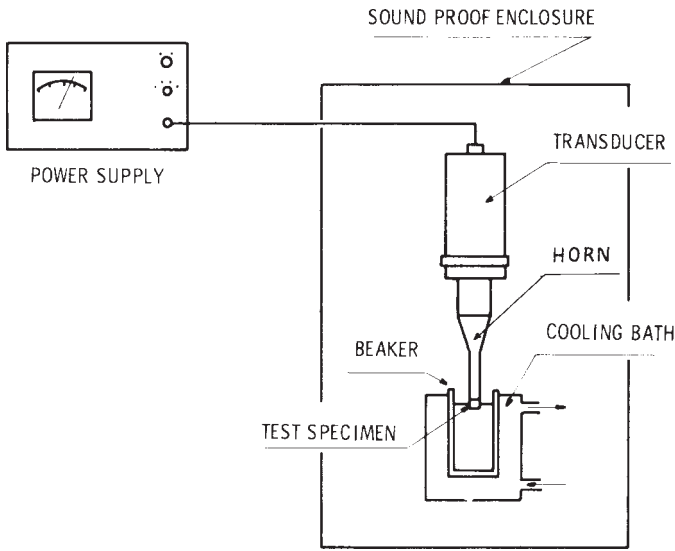

FIG. 2 Schematic of Vibratory Cavitation Erosion Apparatus

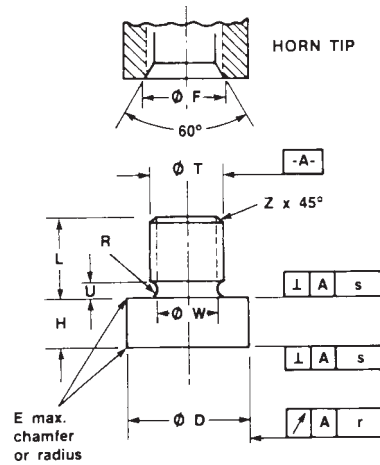

TABLE OF VALUES

	mm	inch
D*	15.9 ± 0.05	0.624 ± 0.002
E*	0.15	0.006
F	(W + 2.2) ± 0.25	(W + 0.09) ± 0.01
H	See Paragraph 7.2	
L	10.0 ± 0.5	0.394 ± 0.02
R	0.8 ± 0.15	0.031 ± 0.006
T	Thread, see Paragraph X2.2.1	
U	2.0 ± 0.5	0.08 ± 0.02
W	Thread minor dia, see Table X2.2	
Z	0.8 ± 0.15	0.031 ± 0.006
r*	0.050	0.002
s*	0.025	0.001

NOTE 1—Asterisk (\*) indicates mandatory; others recommended.

FIG. 4 Dimensions and Tolerances of the Test Specimen

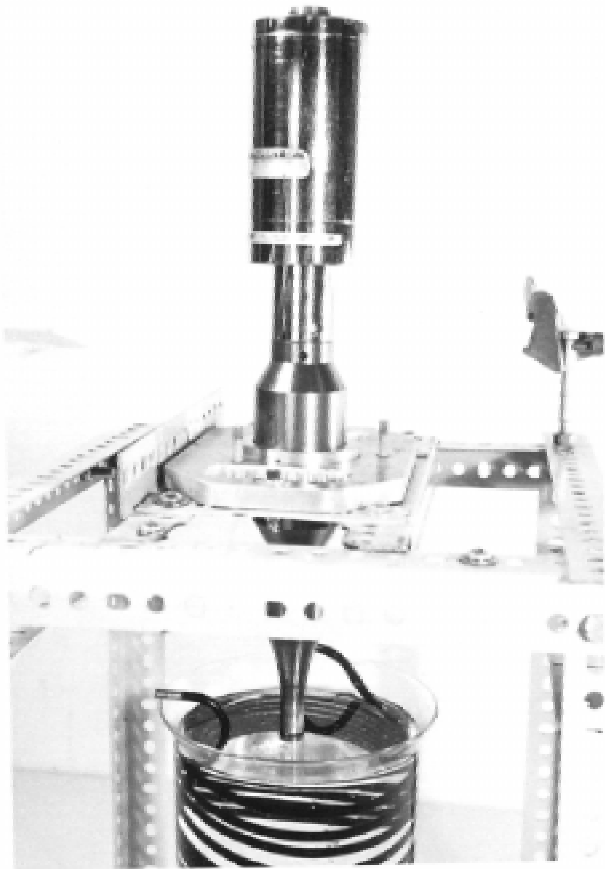

FIG. 3 Photograph of a Typical Apparatus

6.2 To obtain a higher vibratory amplitude at the specimen than at the transducer, a suitably shaped tapered cylindrical member, generally termed the “horn” or “velocity transformer”, is required. Catenoidal, exponential and stepped horn

profiles have been used for this application. The diameter of the horn at its tip shall conform to that specified for the specimen (see 7.1).

6.3 The test specimen (see also Section 7 and Fig. 4) is shaped as a button with the same outer diameter as the horn tip, and has a smaller diameter threaded shank, which is screwed into a threaded hole at the end of the horn. The depth of the hole in the horn shall be the minimum consistent with the required length of engagement of the specimen shank.

6.4 The transducer and horn assembly shall be supported in a manner that does not interfere with, and receives no force input from, the vibratory motion. This can be accomplished, for example, by attaching the support structure to a stationary housing of the transducer, or to a flange located at a nodal plane of the vibrating assembly. It is also necessary to prevent any misalignment of the horn due to forces caused by the electrical cable, cooling system, or transducer enclosure.

6.5 Frequency Control:

6.5.1 The frequency of oscillation of the test specimen shall be 20 ± 0.5 kHz.

6.5.2 The whole transducer-horn-specimen system shall be designed for longitudinal resonance at this frequency.

NOTE 2—If both light and heavy alloys are to be tested, then two horns of different length may be needed in order to permit use of similarly sized specimens. One horn might be used for specimens having densities 5 g/cm<sup>3</sup> or more and tuned for a button mass of about 10 g (0.022 lb), and

the other for densities less than  $5 \text{ g/cm}^3$ , tuned for a button mass of about 5 g (0.011 lb). See also 7.2 and Table X2.2.

6.5.3 A means for monitoring or checking frequency shall be provided; this could be a signal from the power supply or a transducer, feeding into a frequency counter.

#### 6.6 *Amplitude Control:*

6.6.1 Means shall be provided to measure and control vibration amplitude of the horn tip within the tolerances specified in 9.1.1.7 or 9.1.2.

6.6.2 If the ultrasonic system has automatic control to maintain resonance and constant amplitude, amplitude calibration may be done with the specimen in the air and will still apply when the specimen is submerged. This may be done with a filar microscope, dial indicator, eddy-current displacement sensor, or other suitable means (see also Appendix X1).

6.6.3 If the apparatus does *not* have automatic amplitude control, it may be necessary to provide a strain gage or accelerometer on some part of the vibrating assembly for continuous monitoring.

#### 6.7 *Liquid Vessel:*

6.7.1 The capacity of the vessel containing the test liquid shall be at least 2 L. Standard commercially available 2- to 4-L low-form glass beakers (for example; Type II of Specification E 960) are suitable vessels for most applications. If other containers are used they shall have a cylindrical cross section.

6.7.2 The height of the vessel shall be at least 140 mm (5.51 in.).

6.8 Means shall be provided to maintain the temperature of the test liquid at a specified temperature (see 9.1.1.5). This is commonly achieved by means of a cooling bath around the liquid-containing vessel or a cooling coil immersed within it, with suitable thermostatic control.

6.9 A timer should be provided to measure the test duration or to switch off the test automatically after a preset time.

## 7. Test Specimens

7.1 The specimen button diameter (see also 6.3) shall be  $15.9 \pm 0.05 \text{ mm}$  ( $0.626 \pm 0.002 \text{ in.}$ ). The test surface shall be plane and square to the transducer axis within an indicator reading of 0.025 mm (0.001 in.). No rim on or around the specimen test surface shall be used. The circular edges of the specimen button shall be smooth, but any chamfer or radius shall not exceed 0.15 mm (0.006 in.).

7.2 The button thickness of the specimen (Dimension H in Figs. 1 and 4) shall be not less than 4 mm (0.157 in.) and not more than 10 mm (0.394 in.). See Table X2.2 for relationships between button thickness and mass.

7.3 Specimens of different materials to be tested with the same horn should have approximately the same button mass, within the dimensional limits of 7.2. See also 6.5.2.

7.4 Unless otherwise required, the test surface shall be lightly machined, then optionally ground and polished, to a maximum surface roughness of  $0.8 \mu\text{m}$  (32  $\mu\text{in.}$ ), in such a way as to minimize surface damage or alteration. While an extremely fine finish is not required, there shall be no visible pits or scratch marks that would serve as sites for accelerated cavitation damage. Final finishing with 600 grit emery cloth has been found satisfactory.

7.5 The threaded connection between specimen and horn must be carefully designed, and sufficiently prestressed on assembly, to avoid the possibility of excessive vibratory stresses, fatigue failures, and leakage of fluid into the threads. There must be no sharp corners in the thread roots or at the junction between threaded shank and button. A smooth radius or undercut shall be provided at that junction. Other recommendations are given in Fig. 4 and Appendix X2.

7.6 For test materials that are very light, or weak, or brittle, or that cannot be readily machined into a homogeneous specimen, it may be desirable to use a threaded stud made of the same material as the horn (or some other suitable material) and to attach a flat disk of the test material by means of brazing, adhesives, or other suitable process. Such a disk shall be at least 3 mm (0.12 in.) in thickness, unless it is the purpose of the specimen to test an overlay or surface layer system. In that case, the test report shall describe the overlay material, its thickness, the substrate material, and the deposition or attachment process. For such nonhomogeneous specimens, the button weight recommendation given in 7.3 still applies.

7.7 No flats shall be machined into the cylindrical surface of the specimen or horn tip. Tightening of the specimen should be accomplished by a tool that depends on frictional clamping but does not mar the cylindrical surface, such as a collet or specially designed clamp-on wrench, preferably one that can be used in conjunction with a torque wrench. (See 10.3 and Appendix X2 for tightening requirements and guidelines.)

## 8. Calibration

### 8.1 *Calibration of Apparatus:*

8.1.1 Perform a frequency and amplitude calibration of the assembled system at least with the first sample of each group of specimens of same button mass and length.

8.1.2 Perform tests with specimens of the standard reference material specified in 8.3 from time to time to verify the performance of the apparatus. Do this at standard test conditions (see 8.1.3) even if the apparatus is normally operated at optional conditions.

8.1.3 The standard reference material is annealed wrought Nickel 200 (UNS N02200), conforming to Specification B 160. This is a commercially pure (99.5 %) nickel product; see Table 1 for its properties.

8.1.4 The approximate range of test results to be expected for this material, under the standard test conditions specified in Section 9, is shown in Fig. 5 (based on results reported in an interlaboratory study). The appearance of a test specimen at several stages in a test is shown in Fig. 6.

### 8.2 *Calibrating the Test Program:*

8.2.1 In each major program include among the materials tested one or more reference materials, tested at the same condition to facilitate calculation of “normalized erosion resistance” of the other materials.

8.2.2 In all cases include annealed Nickel 200 as specified in 8.1.3.

8.2.3 A reference material of lesser erosion resistance is Aluminum Alloy 6061-T6 (UNS A96061, Specification B 211).

**TABLE 1 Material Used in Interlaboratory Study**

Designation: Nickel 200, UNS N02200, ASTM B 160	
Composition (limit values): Ni 99 min; max others: 0.25 Cu, 0.40 Fe, 0.35 Mn, 0.15 C, 0.35 Si, 0.01 S	
Specific gravity (nominal): 8.89	
Form: 0.75-in. (19 mm) rod, cold drawn and annealed	
Properties:	
Yield strength (nominal) <sup>A</sup> :	103 to 207 MPa (15 to 30 ksi)
(measured) <sup>B</sup> :	284 MPa (41.2 ksi)
Tensile strength (nominal):	379 to 517 MPa (55 to 75 ksi)
(measured):	586 MPa (85 ksi)
Elongation (nominal):	40 to 55 %
(measured):	58 %
Reduction of area (nominal):	N/A
(measured):	76 %
Hardness (nominal):	45 to 70 HRB, 90 to 120 HB
(measured):	49 HRB

<sup>A</sup>"Nominal" properties are from "Huntington Alloys" data sheets. (Strength properties were listed in ksi; SI values in this table are conversions.)

<sup>B</sup>"Measured" properties reported from tests on sample from same rod as used for erosion test specimens. (Strength properties were reported in ksi; SI values in this table are conversions.)

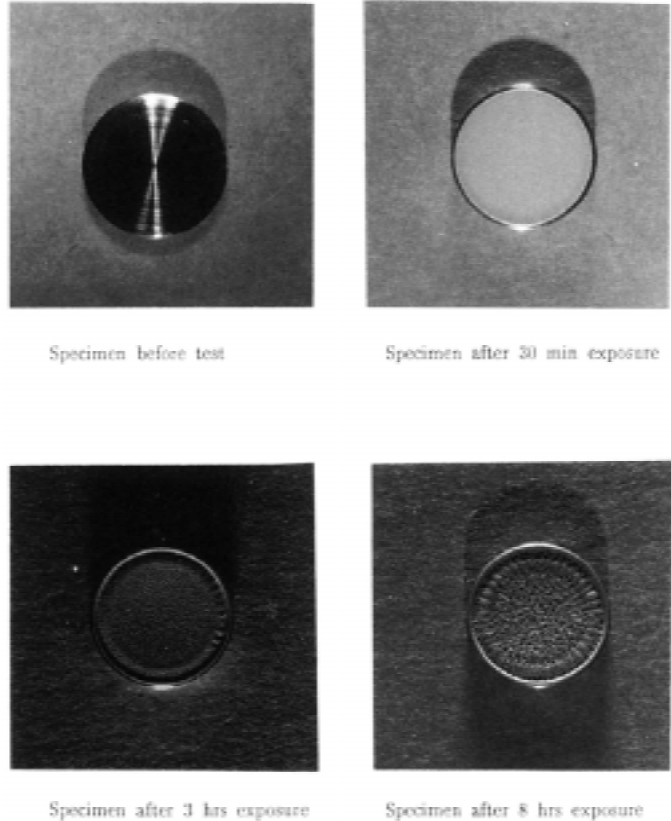

**FIG. 6 Photographs of a Nickel 200 Specimen Taken at Several Cumulative Exposure Times**

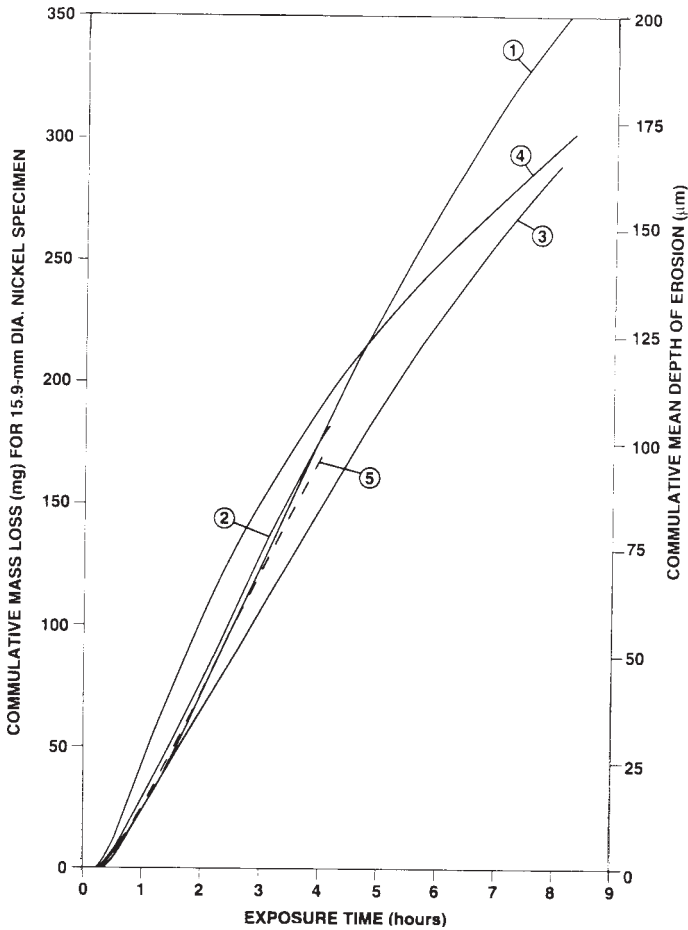

NOTE 1—Each curve represents an average of two or three replicate tests.

**FIG. 5 Cumulative Erosion-Time Curves for Nickel 200 From Five Laboratories**

8.2.4 A reference material of greater erosion resistance is annealed austenitic stainless steel Type 316, of hardness 150 to 175 HV (UNS S31600, Specification A 276).

**9. Test Conditions**

*9.1 Standard Test Conditions:*

9.1.1 If this test method is cited without additional test parameters, it shall be understood that the following test conditions apply:

9.1.1.1 The test liquid shall be distilled or deionized water, meeting specifications for Type III reagent water given by Specification D 1193.

9.1.1.2 The depth of the liquid in its container shall be at least 100 mm (3.94 in.), with cooling coils (if any) in place.

9.1.1.3 The immersion depth of the specimen test surface shall be 12 ± 4 mm (0.47 ± 0.16 in.).

9.1.1.4 The specimen (horn tip) shall be concentric with the cylindrical axis of the container, within ±5 % of the container diameter.

9.1.1.5 Maintain the temperature of the test liquid at 25 ± 2°C (77 ± 3.6°F).

9.1.1.6 The gas over the test liquid shall be air, at a pressure differing less than 6 % from one standard atmosphere (101.3 kPa; 760 mm (29.92 in.) Hg). If the pressure is outside this range, for example, because of altitude, this must be noted in the report as a deviation from standard conditions.

9.1.1.7 The peak-to-peak displacement amplitude of the test surface of the specimen shall be 50 µm (0.002 in.) ±5 % throughout the test.

9.1.2 An alternative peak-to-peak displacement amplitude of 25  $\mu\text{m}$  (0.001 in.) may be used for weak, brittle, or nonmetallic materials that would be damaged too rapidly or could not withstand the inertial vibratory stresses with the standard amplitude of 9.1.1.7. See Appendix X2 for guidance. This amplitude may also be appropriate for erosion-corrosion studies. If this amplitude is used, this must be clearly stated in conjunction with any statement that this test method (Test Method G 32) was followed.

#### 9.2 *Optional Test Conditions:*

9.2.1 The standard test conditions of 9.1.1 satisfy a large number of applications in which the relative resistance of materials under ordinary environmental conditions is to be determined. However, there can be applications for which other temperatures, other pressures, and other liquids must necessarily be used. When such is the case, any presentation of results shall clearly refer to and specify all deviations from the test conditions of 9.1.1. (See also 12.1.) Deviations from standard test conditions should not be used unless essential for purposes of the test.

9.2.2 Investigations of the effect of liquid temperature on cavitation erosion (see X3.2.2) have shown that the erosion rate peaks strongly at a temperature about halfway between freezing and boiling point, for example, for water under atmospheric pressure at about 50°C (122°F). Near the standard temperature of 25°C, each increase of 1°C probably increases the erosion rate by 1 to 2%. Thus, there may be economic incentive to conduct water tests with especially resistant materials (for example, tool steels, stellites) at a temperature higher than that specified in 9.1.1.5. This can generally be done simply by adjusting the temperature control, since without any cooling the liquid temperature may rise even beyond the optimum.

9.2.3 To conduct specialized tests at elevated temperature or pressure, or with difficult or hazardous liquids, the liquid-containing vessel must be appropriately designed. Usually, a seal must be provided between the vessel and the horn assembly. While bellows seals can be used, it is preferable to design the supporting features (see 6.4) to incorporate the sealing function.

9.2.4 The procedures specified in Section 10 still apply with the possible exception of 10.1. Under certain conditions this step may not be practical (or necessary). Opening and disassembling the test vessel for this purpose may distort the erosion results by causing extraneous oxidation, etc., through additional exposure to air.

9.2.5 For tests intended to simulate cavitation erosion-corrosion conditions, it may be appropriate to operate the equipment in a pulsed or cyclic manner. A 60-s-on/60-s-off cycle is recommended as a basic duty cycle for such tests. If the nature of the interactions between erosion and corrosion is to be studied, then varying duty cycles may be required.

## 10. Procedure

10.1 For each new test specimen, clean the liquid vessel, fill it with fresh liquid, and vibrate a dummy specimen (of high erosion resistance) in it for 30 min to stabilize the gas content of the liquid.

10.2 Clean the test specimen carefully and weigh it on an accurate and sensitive balance (0.1-mg accuracy and sensitivity) before the test.

10.3 After making sure that the threads and contact surfaces of the horn and the specimen are perfectly free of debris, thread the specimen into the horn until finger tight, then tighten to a suitable torque. The resulting prestressing of the threaded shank must be sufficient to ensure that contact is not lost between horn and specimen shoulder as a result of vibratory inertial loads. See guidelines given in Appendix X2. (**Warning**—Fatigue failure of the threaded portion of the specimens may become a problem under some circumstances. The specimen must be tightly secured to the horn to ensure good energy transmission and avoid any separation between specimen button and horn tip. A very thin (virtually invisible) layer of liquid or solid boundary lubricant may be used to ensure effective preloading and to prevent galling between specimen and horn. However, excessive amounts of liquid or grease lubricants can result in damage to mating surfaces in the joint, due to cavitation of the lubricant. See also Appendix X2.) (**Warning**—Heating of the horn and unusual noise are indications of either fatigue failure or improper tightening of the specimen, or presence of dirt or excessive amount of lubricant.)

10.4 Insert the specimen into the liquid to a depth as specified in 9.1.1.3, and concentric with the container as specified in 9.1.1.4.

10.5 Start the apparatus and the timer, and bring the amplitude as quickly as possible to the specified value. On apparatus with automatic amplitude control this is usually accomplished simply by repeating the control settings or dial readings determined in a previous calibration (see 6.6 and 8.1.1). Also make sure that the temperature is stabilized as soon as possible. Monitor these conditions from time to time.

10.6 At the end of the test interval, stop the apparatus, remove the specimen, and carefully clean, dry and weigh it to determine its new mass and hence the mass loss. Repeat the cleaning, drying and weighing operations until two successive weighings yield identical (or acceptably similar) readings, unless prior qualification of the cleaning procedure has proved such repetition unnecessary. (**Warning**—Very careful cleaning and drying of specimens before each weighing is essential. An ultrasonic cleaning bath (such as can be bought for cleaning dentures), containing solvents such as acetone, trichloroethylene or ethyl alcohol has been found satisfactory. For general drying a hair dryer has been found satisfactory; for porous (for example, cast) materials a vacuum desiccator may be used. Do *not* dry with cloth or paper products which may leave lint on the specimen.)

10.7 Repeat 10.3-10.6 for the next test interval, and so on until the criteria of 10.10 or 10.11 have been met. It is recommended that a running plot of cumulative mass loss versus cumulative exposure time be maintained.

10.8 After 8 to 12 h of testing with the same liquid, strain out the debris, or discard and refill with fresh liquid, and precondition it with a dummy specimen as in 10.1.

10.9 As shown in Fig. 7, the rate of mass loss varies with exposure time. The intervals between measurements must be such that a curve of cumulative mass loss versus cumulative

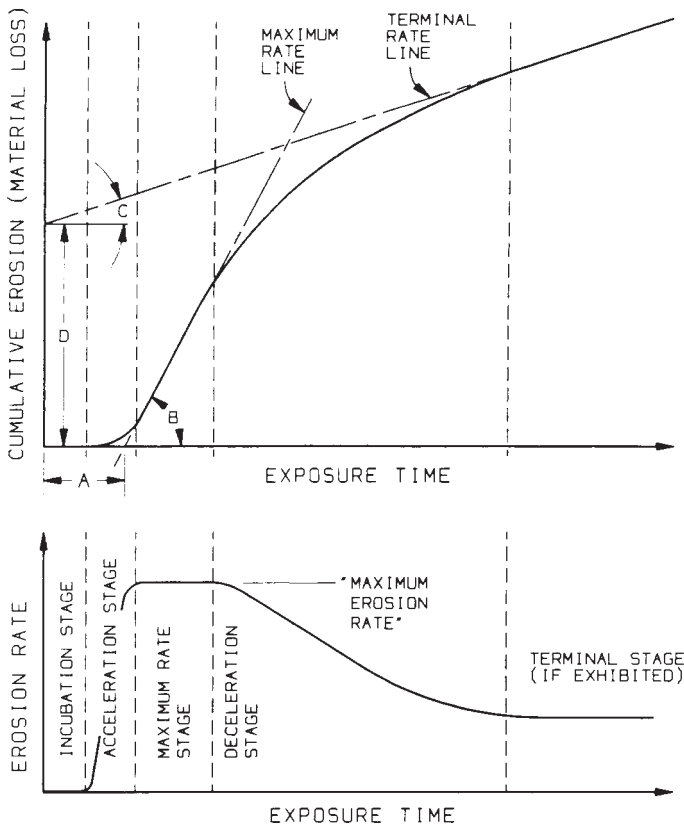

NOTE 1—A = nominal incubation time; tan B = maximum erosion rate; tan C = terminal erosion rate; and D = terminal line intercept.

**FIG. 7 Characteristic Stages of the Erosion Rate-Time Pattern, and Parameters for Representation of the Cumulative Erosion-Time Curve**

exposure time can be established with reasonable accuracy. The duration of these intervals, therefore, depends upon the test material and its erosion resistance and cannot be rigorously specified in advance. Suitable intervals may be approximately 15 min for aluminum alloys, 30 min for pure nickel, 1 to 2 h for stainless steel, and 4 to 8 h for stellite. Intervals at the beginning of a test may need to be shorter if the true incubation period and shape of the acceleration stage are to be determined.

10.10 It is recommended that the testing of each specimen be continued at least until the average rate of erosion (also termed cumulative erosion rate) has reached a maximum and begins to diminish, that is, until the “tangent erosion rate” line (see 3.1) can be drawn.

10.11 It is recommended that when several materials are to be compared, all materials be tested until they reach comparable mean depths of erosion.

## 11. Calculation or Interpretation of Results

11.1 Interpretation and reporting of cavitation erosion test data is made difficult by two factors. The first is that the rate of erosion (material loss) is not constant with time, but goes through several stages (see Fig. 7). This makes it impossible to represent the test result fully by a single number, or to predict long-term behavior from a short-term test. The second is that there is no independent or absolute definition of “erosion

resistance”, nor can units of measurement be ascribed to it. The following paragraphs describe required as well as optional data interpretation steps.

11.2 The primary result of an erosion test is the cumulative erosion-time curve. Although the raw data will be in terms of mass loss versus time, for analysis and reporting purposes this should be converted to a “mean depth of erosion” (MDE) versus time curve, since a volumetric loss is more significant than a mass loss when materials of different densities are compared. Calculate the mean depth of erosion, for the purpose of this test method, on the basis of the full area of the test surface of the specimen, even though generally a narrow annular region at the periphery of the test surface remains virtually undamaged. For the button diameter specified in 7.1, this area is 1.986 cm<sup>2</sup> (0.308 in.<sup>2</sup>).

11.3 Because of the shape of the cumulative erosion-time curve, it is not meaningful to compare the mass loss or MDE for different materials after the same cumulative exposure time. (The reason is that a selected time may still be within the incubation or acceleration stage for a very resistant material, whereas for a weak material the same time may be within the maximum rate or deceleration stage.) However, for a crude single-number comparison one may compare the cumulative exposure times to reach the same cumulative MDE; in order to standardize this approach a value of 100 μm is chosen, which should be within the maximum erosion rate stage. For very resistant materials, for which the testing time would be excessive, 50 μm may be substituted.

11.4 For a more complete description of the test result, use the following parameters (refer to Fig. 7):

11.4.1 The “maximum rate of erosion”, that is, slope of the straight line that best approximates the linear (or nearly linear) steepest portion of the cumulative erosion-time curve, expressed in micrometres per hour. This is the most commonly used single-number result found in the literature, and its use is *required* in this test method.

11.4.2 The “nominal incubation time”, that is, intercept of the maximum erosion rate line on the time axis. This also is *required*.

11.4.3 The “terminal erosion rate” if exhibited in a test that is continued for a sufficiently long time. This is optional.

11.4.4 If the terminal erosion rate is reported, then the MDE corresponding to the intersection of the terminal-rate line with the maximum-rate line, or alternatively its intercept on the MDE axis, must also be reported.

11.5 The use of other carefully defined test result representations, in addition to those required above, is optional. Some that have been used include the “tangent erosion rate” (the slope of a straight line drawn through the origin and tangent to the knee of the cumulative erosion-time curve), the MDE of that tangency point, and curves of “instantaneous erosion rate” versus time or of “average erosion rate” versus time.

11.6 This test method is sufficiently tightly specified that direct comparisons between results obtained in different laboratories are meaningful, provided that the standard test configuration, conditions, and procedures are rigorously adhered to. However, to facilitate comparisons between results from different types of cavitation erosion tests, it is also necessary to



present results in normalized form, relative to one or more standard reference materials included in the test program (see 8.5). Specific parameters used include *normalized erosion resistance* and *normalized incubation resistance* (see definitions in Section 3).

## 12. Report

12.1 Report clearly any deviations from the standard specifications for the apparatus (Section 6), test specimen (Section 7), and test conditions (9.1) as well as the reasons for these deviations. This includes specification of the test liquid, temperature and pressure of the liquid, vibration amplitude and frequency, etc. When results from such tests are reported in abbreviated form, state that “ASTM Test Method G 32 modified” was used and specify deviations from 9.1.

12.2 Report the following information, if applicable, for each material tested:

12.2.1 Identification, specification, composition, heat treatment, and mechanical properties including hardness, as measured on the specimen or the stock from which it came,

12.2.2 Method of preparing test specimens and test surface (preferably including initial surface roughness measurement),

12.2.3 Number of specimens tested,

12.2.4 A tabulation giving the following information on each specimen tested:

12.2.4.1 Total cumulative length of exposure, hours (h),

12.2.4.2 Total cumulative mass loss, milligrams (mg),

12.2.4.3 Total cumulative mean depth of erosion, micrometres ( $\mu\text{m}$ ), calculated from mass loss, specimen area (see 11.2), and specimen density,

12.2.4.4 Maximum rate of erosion (see 11.4.1),

12.2.4.5 Nominal incubation time (see 11.4.2), and

12.2.4.6 The cumulative exposure time to reach a mean depth of erosion of 100  $\mu\text{m}$  (or alternatively, 50  $\mu\text{m}$ ; see 11.3).

12.2.5 A tabulation giving the normalized erosion resistance and normalized incubation resistance for each material tested, relative to one of the reference materials (see section 8.2) included in the test. Calculate these values from averaged data of replicate tests of the same material.

12.2.6 A full report should also include the following on each specimen tested:

12.2.6.1 Tabulation of cumulative mass losses and corresponding cumulative exposure time for each specimen, and

12.2.6.2 Plot of cumulative mean depth of erosion versus cumulative exposure time for each specimen.

12.3 Any special occurrences or observations should be noted in the report.

## 13. Precision and Bias

### 13.1 Precision:

13.1.1 The limited interlaboratory study on which the following information is based did not meet all the requirements of Practice E 691; therefore, the terms “repeatability” and “reproducibility” will not be used except in quotation marks. However, the variabilities are calculated as prescribed by

Practice E 691. The statistics are based on the tests of one material, Nickel 200, by five laboratories, using this test method with only minor deviations. All laboratories used specimens cut from the same bar. The material properties are given in Table 1. A research report has been filed with ASTM.<sup>10</sup>

13.1.2 A summary of the test result statistics is given in Table 2, and averaged erosion-time curves for each lab are shown in Fig. 5. It will be seen that the curve for Laboratory 4 is somewhat anomalous; it is more “S-shaped” and exhibits less of a steady-state maximum-rate stage than the others. The reasons for this are not clearly known; curves similar to those from Laboratory 4 can be found in the literature. However, because of this difference and the greater variability of Laboratory 4 results, and some overheating problems reported by that Laboratory, its data may be suspect and therefore pooled statistics have been calculated both with and without Laboratory 4 results included. Additional remarks follow in 13.1.3 and 13.1.4.

### 13.1.3 Within-Laboratory Variability:

13.1.3.1 For maximum erosion rates, the pooled coefficient of variation was almost 9 %, but this is primarily due to the poor results from Laboratory 4; if this is excluded, the value drops to 4.2 %. Moreover, Laboratory 1, 2, and 3 each achieved individual within-lab coefficients of variation of less than 3 %. These results suggest that a laboratory that obtains a value of 5 % or more should carefully review its specimen preparation and testing procedures.

13.1.3.2 For the other results, excluding Laboratory 4 did not make much difference to the pooled statistic, but Laboratories 1 through 3 generally had the best individual results: For the time to 100  $\mu\text{m}$  MDE, while the pooled value is about 6 %, Laboratories 1 through 3 each achieved better than 2 %. For the time to 50  $\mu\text{m}$  MDE, the pooled value is again about 6 %, but Laboratories 1 through 3 each had less than 4 %. The greatest within-lab variability is found for the incubation period; the pooled value was about 20 % and the best individual lab result was 14 %.

13.1.4 *Between-Laboratory Variability*—Again, excluding Laboratory 4 data improved the pooled statistics, except for the incubation period. Then the “reproducibility” coefficient of variation for all variables except the incubation period became 8 to 10 %; for the incubation period it remained about 30 %.

13.2 *Bias*—No statement can be made regarding the bias of this test method, because there is no absolute definition or measurement of erosion resistance. Erosion test methods measure only relative results between different materials, and these can differ according to the test method or test conditions employed.

## 14. Keywords

14.1 cavitation; cavitation erosion; erosion by liquids; erosion-corrosion; erosion of solids; erosion resistance; erosion test; vibratory cavitation

<sup>10</sup> Available from ASTM Headquarters. Request RR:G02-1007.

**TABLE 2 Statistical Results of Interlaboratory Study**

Test Result: Statistic	Maximum erosion rate ( $\mu\text{m}/\text{h}$ )	Incubation time (min)	Time to 50 $\mu\text{m}$ MDE (min)	Time to 100 $\mu\text{m}$ MDE (min)
Individual Laboratory Results <sup>A</sup>				
Laboratory 1 average:	29.6	29.7	131	234
standard deviation:	0.88	6.8	4.7	4.6
coefficient of variation %:	3.0	22.9	3.6	2.0
Laboratory 2 average:	27.6	19.0	128	236
standard deviation:	0.66	2.7	2.9	4.5
coefficient of variation %:	2.4	14.2	2.3	1.9
Laboratory 3 average:	23.5	18.3	147	275
standard deviation:	0.14	2.5	3.1	4.5
coefficient of variation %:	0.6	13.7	2.1	1.6
Laboratory 4 average:	37.6	16.0	99	211
standard deviation:	5.30	4.2	7.1	21.9
coefficient of variation %:	14.1	26.2	7.2	10.4
Laboratory 5 average:	26.0	19.7	133	248
standard deviation:	1.90	3.5	14.9	24.7
coefficient of variation %:	7.3	17.8	11.2	10.0
Average of laboratory averages:	28.8 (26.6) <sup>B</sup>	20.5 (21.7)	127 (135)	241 (248)
Pooled Variabilities—Absolute Values				
“Repeatability” standard deviation:	2.57 (1.12) <sup>B</sup>	4.24 (4.24)	7.88 (8.07)	15.2 (13.0)
“Reproducibility” standard deviation:	5.76 (2.74)	6.34 (6.40)	18.6 (10.6)	26.6 (21.7)
“95 % Repeatability Limit” <sup>C</sup> :	7.21 (3.13)	11.9 (11.9)	22.1 (22.6)	42.6 (36.4)
“95 % Reproducibility Limit”:	16.1 (7.67)	17.7 (17.9)	52.1 (29.8)	74.6 (60.8)
Pooled Variabilities—Normalized Values <sup>D</sup>				
“Repeatability” coefficient of variation, %:	8.9 (4.2) <sup>B</sup>	20.7 (19.6)	6.2 (6.0)	6.3 (5.2)
“Reproducibility” coefficient of variation, %:	20.0 (10.3)	30.9 (29.5)	14.6 (7.9)	11.1 (8.7)
“95 % Repeatability Limit” coefficient, %:	25 (12)	58 (55)	17 (17)	18 (14)
“95 % Reproducibility Limit” coefficient, %:	56 (29)	86 (83)	41 (22)	31 (25)

<sup>A</sup>All laboratory results are based on three replications, except all data for Laboratory 4 (two replications), and “time to 100  $\mu\text{m}$ ” for Laboratory 5 (two replications).

<sup>B</sup>Numbers in parentheses are the statistics with Laboratory 4 excluded.

<sup>C</sup>A “95 % limit” represents the difference between two random test results that would not be exceeded in 95 % of such pairs (see Practice E 177).

<sup>D</sup>Normalized variabilities: coefficients of variation are corresponding standard deviations, and “95 % limit” coefficients are corresponding limits, expressed as percent of the “average of laboratory averages”.

## APPENDIXES

### (Nonmandatory Information)

#### X1. AMPLITUDE MEASUREMENT AND CALIBRATION

X1.1 Commercially-obtained ultrasonic equipment is generally provided with a meter or power adjustment that can be used to set and monitor vibration amplitude once it has been calibrated against a direct measurement of tip amplitude. The following subsections briefly describe some calibration techniques that have been found satisfactory, as well as alternative monitoring methods.

X1.2 *Filar Microscope*—This technique requires a microscope having a filar scale with divisions of 5  $\mu\text{m}$  (0.0002 in.) or smaller, and a very bright light source. A light scratch mark, perpendicular to the horn axis, may be scribed on the side of the horn tip or specimen, if necessary. The width of an appropriate mark or edge perpendicular to the horn axis is observed with the apparatus turned off, and its “apparent

width” observed with the apparatus turned on. The difference is the peak-to-peak amplitude of vibration.

X1.3 *Dial Indicator*—This technique requires a precision dial indicator with scale divisions of 2.5  $\mu\text{m}$  (0.0001 in.) or smaller. The indicator is mounted on the platform or base of the apparatus, with the indicator tip contacting the face of the horn tip or specimen. Readings are taken with the apparatus stationary and with it turned on. Since the indicator cannot follow the horn tip vibrations, it then takes on a position corresponding to the peak displacement. Thus the difference in the readings is the rest-to-peak amplitude.

X1.4 *Noncontacting Probes*—Various noncontacting proximity probes and vibration probes are commercially available.

**TABLE X2.1 Properties of Specimen Threads**

 NOTE 1—Dimensions are given in mm or mm<sup>2</sup>. (Dimensions in parentheses are given in in. or in.<sup>2</sup>.)

		Optional	Recommended Group A			Group B	
		7/16 UNF-20	3/8 UNF-24	M10-1.0	M10-1.25	5/16 UNF-24	M8-1.0
Nominal diameter	<i>D</i>	11.11 (0.4375)	9.5 (0.375)	10.00 (0.3937)	10.00 (0.3937)	7.94 (0.3125)	8.00 (0.3150)
Pitch	<i>p</i>	1.270 (0.0500)	1.059 (0.0417)	1.000 (0.0394)	1.250 (0.0492)	1.059 (0.0417)	1.000 (0.0394)
Depth of Ext'l thread	<i>h</i>	0.779 (0.03067)	0.649 (0.02556)	0.613 (0.02415)	0.767 (0.03019)	0.649 (0.02556)	0.613 (0.02415)
Pitch Line diameter	<i>D<sub>p</sub></i>	10.29 (0.4050)	8.84 (0.3479)	9.35 (0.3681)	9.19 (0.3617)	7.25 (0.2854)	7.35 (0.2894)
Minor diameter	<i>D<sub>R</sub></i>	9.56 (0.3762)	8.23 (0.3239)	8.77 (0.3454)	8.47 (0.3333)	6.64 (0.2614)	6.77 (0.2667)
Area of minor diameter	<i>A<sub>R</sub></i>	71.68 (0.1111)	53.16 (0.0824)	60.45 (0.0937)	56.26 (0.0872)	34.65 (0.0537)	36.06 (0.0559)
"Tensile stress area" <sup>A</sup>	<i>A<sub>S</sub></i>	76.58 (0.1187)	56.65 (0.0878)	N/A	N/A	37.42 (0.0580)	N/A
Width of horn shoulder <sup>B</sup>	<i>b</i>	2.38 (0.0938)	3.18 (0.125)	2.95 (0.116)	2.95 (0.116)	3.96 (0.156)	3.94 (0.155)
Stress area of horn <sup>B</sup>	<i>A<sub>H</sub></i>	100.6 (0.156)	126.5 (0.196)	119.4 (0.185)	119.4 (0.185)	148.4 (0.230)	147.7 (0.229)
<i>A<sub>H</sub>/A<sub>R</sub></i>	...	1.40	2.38	1.97	2.12	4.38	4.10

<sup>A</sup>Use *A<sub>R</sub>* in place of *A<sub>S</sub>* if the latter is not available.

<sup>B</sup>*b* = (0.625 - *D*)/2 in.; *A<sub>H</sub>* = (π/4) (0.625<sup>2</sup> - *D*<sup>2</sup>) in.<sup>2</sup>.

Any such vibration probe may be suitable. The suitability of a proximity probe would depend on whether it would respond to the closest position of a vibrating surface.

**X1.5 Strain Gages**—Theoretically, if the exact shape of the horn is known and its vibratory strain measured by a strain gage at one location, the corresponding tip amplitude can be calculated. It can also be calibrated with one of the other methods listed above. This technique would permit constant

monitoring of the amplitude during a test with the tip immersed.

**X1.6 Accelerometers**—An accelerometer sensing axial motion can be attached at some suitable location that is not a node (for instance on top of the transducer stack), and its signal calibrated by one of the other methods or by theoretical calculation.

## X2. RECOMMENDATIONS FOR SPECIMEN THREADS AND PRESTRESSING TORQUE

### X2.1 Basic Considerations:

**X2.1.1** The prestressing force in the threaded shank, produced by adequate torquing on assembly, must exceed the peak vibratory inertial force on the specimen button, so that a positive contact pressure is always maintained between the specimen shoulder and the horn tip during each cycle of vibration. This is essential for two reasons: firstly, to reduce the alternating force imposed on the threaded shank, by spreading it over the horn tip area as well, and secondly, to prevent any leakage of the test liquid into the threads, where it could cause damage and heating.

**X2.1.2** The prestress in the threaded shank, on the other hand, must not be so great that it, in combination with the reduced but still existing alternating stress, could cause failure in the threads or in the junction between threads and button. It should be noted that while in some bolting applications a proper preload can virtually eliminate all alternating stresses from the threaded member, that cannot be assumed true in this case. The reason is that the horn tip area and rigidity is not vastly greater than that of the shank, so that in essence the alternating load will be shared by the horn and the shank in proportion to their areas and their moduli of elasticity.

**X2.1.3** A final requirement, usually met without difficulty, is that the horn annulus cross-section area, just below the top of its threaded hole, must resist the full inertial alternating force due to the whole specimen and horn tip region below that section.

### X2.2 Thread Selection:

**X2.2.1** While this test method does not mandate the use of a particular thread for the specimen shank, the following thread and shank dimensions are recommended:

**X2.2.2** The preferred recommended threads, to be designated "Group A", are either 3/8UNF-24, M10-1.0, or M10-1.25. Alternative recommended threads, to be designated "Group B", are either 5/16-UNF-24 or M8-1.0. Some investigators have used 7/16-UNF-20. The inch-based unified threads should be Class 2 or, if desired, Class 3. The metric threads should be of the "medium" class of fit (6g and 6H) or, if desired, of the "close" class of fit (4h and 5H). The thread roots of the external thread must be rounded; the specification of the British standards, calling for a root radius of 0.1443 times pitch, may be followed. Some properties of these threads are given in Table X2.1.

**TABLE X2.2 Button Mass and Length Relationships**

Material Specific Gravity	Aluminum 2.7	Titanium 4.5	Steel 7.9	Nickel, Brass, Stellite 8.8
Button Length mm (in.)	Corresponding Mass, g/(weight, lb)			
4.0 (0.157)	2.14 (0.00472)	3.57 (0.00787)	6.27 (0.0138)	6.99 (0.0154)
6.0 (0.236)	3.22 (0.00709)	5.36 (0.0118)	9.41 (0.0207)	10.48 (0.0231)
8.0 (0.315)	4.29 (0.00945)	7.15 (0.0157)	12.55 (0.0276)	13.98 (0.0308)
10.0 (0.394)	5.36 (0.0118)	8.94 (0.0197)	15.69 (0.0346)	17.47 (0.0385)
Button Mass, g (weight, lb)	Corresponding		Length, mm/(in.)	
4 (0.0088)	7.46 (0.294)	4.47 (0.176)	2.55 (0.100)	2.29 (0.090)
5 (0.0110)	9.33 (0.367)	5.59 (0.220)	3.19 (0.125)	2.86 (0.113)
8 (0.0176)	14.93 (0.588)	8.95 (0.352)	5.10 (0.201)	4.58 (0.180)
10 (0.0220)	18.66 (0.735)	11.19 (0.440)	6.37 (0.251)	5.72 (0.225)
Inertial Accelerations of Button				
At 20 kHz, 50 μm peak-to-peak: $3.95 \times 10^5 \text{ m/s}^2 (40.3 \times 10^3 \text{ G}^m)$				
At 20 kHz, 25 μm peak-to-peak: $1.97 \times 10^5 \text{ m/s}^2 (20.1 \times 10^3 \text{ G}^m)$				

X2.2.3 The length of the threaded shank should be  $10 \pm 0.5$  mm (0.394 ± 0.02 in.).

X2.2.4 At the junction between the threaded shank and the shoulder of the specimen, there should be a smooth radius of at least 0.65 mm (0.025 in.), and preferably a smooth undercut of length 2 mm (0.08 in.), as shown in Fig. 4. The horn should have a corresponding countersink chamfer as also shown in this figure. The countersink should be no greater than necessary, and not unduly reduce the contact surface between horn tip and specimen shoulder.

### X2.3 Relation Between Tightening Torque and Preload:

X2.3.1 For the recommended threads, the following equations may be used to determine the required torque,  $T$ , to obtain a desired prestress force,  $F_s$ . Guidelines for selecting  $F_s$  are given in X2.4.

X2.3.2 For thread group “A”:

$$\begin{aligned} T/F_s &= [0.472\mu + 0.0076] (\text{lb-in./lb}) & (X2.1) \\ &= [0.012\mu + 0.00019] (\text{N-m/N}) \end{aligned}$$

X2.3.3 For thread group “B”:

$$\begin{aligned} T/F_s &= [0.415\mu + 0.0062] (\text{lb-in./lb}) & (X2.2) \\ &= [0.0105\mu + 1.57 \times 10^{-4}] (\text{N-m/N}) \end{aligned}$$

X2.3.4 In the above equations,  $\mu$  is the coefficient of friction, which may be assumed as 0.2 for dry engagement and 0.1 for lubricated engagement.

### X2.4 Prestressing Guidelines:

X2.4.1 Experience has shown that prestressing the specimen shank to about one half of its yield strength is satisfactory in many cases. However, to evaluate the prestressing limits more closely and identify potential problems, the following calculation steps may be performed.

X2.4.2 Calculate the peak inertial force ( $F_b$ ) on the specimen button as follows. Determine the button mass,  $M$ , in grams. (See Table X2.2 for guidance.) Then for the standard

peak-to-peak displacement amplitude of 50 μm at 20 kHz:

$$F_b, N = 400 M \quad (X2.3)$$

or:

$$F_b, \text{ lbf} = 90 M$$

For the alternative displacement amplitude of 25 μm, the values are half of the above. The minimum prestress force to be considered should be at least 1.5  $F_b$ . The maximum safe prestress force is determined by the following steps.

X2.4.3 Calculate the alternating force amplitude on the specimen threads,  $F_a$ , that applies when the preload exceeds  $F_b$ :

$$F_a = \frac{F_b}{1 + (A_H/A_R)(E_H/E_S)} \quad (X2.4)$$

where:

- $A_H$  = stress area of horn outside of threads,
- $A_R$  = stress area of specimen shank,
- $E_H$  = modulus of elasticity of horn material, and
- $E_S$  = modulus of elasticity of specimen material.

Values of ( $A_H/A_R$ ) for the recommended threads are given in Table X2.1.

X2.4.4 Calculate a conservative upper limit to the prestress force  $F_s$  using the following approximation:

$$F_{s_{\max}} = S_y A_s - 8 F_a \quad (X2.5)$$

where:

- $S_y$  = yield strength of specimen material, and
- $A_s$  = tensile stress area of the thread, given in Table X2.1.

X2.4.5 If  $F_{s_{\max}}$  from (Eq X2.5) exceeds  $2 F_b$  from (Eq X2.3), select an intermediate value of  $F_s$ , preferably at least  $2 F_b$  and calculate the required set-up torque as described in X2.3.

X2.4.6 If  $F_{s_{\max}}$  from (Eq X2.5) is less than  $2 F_b$ , recalculate  $F_{s_{\max}}$  using the following slightly more detailed approximation, adapted from (Eq 33) of Ref. (1):

$$F_{s_{\max}} = S_u A_s / N_s - K_f F_a (S_u / S_e) \quad (X2.6)$$

where:

$N_s$  = factor of safety, preferably at least 1.5,  
 $S_u$  = ultimate strength of specimen material,  
 $S_e$  = unnotched endurance limit of specimen material for fully reversed alternating loading,  
 $K_f$  = fatigue notch factor  
 $= q(K_t - 1) + 1$ ,  
 $K_t$  = stress concentration factor, about 6.7 for threads, and  
 $q$  = notch sensitivity factor, dependent on notch radius. For threads root radius of about 0.15 mm (0.006 in.),  $q \sim 0.5$  for annealed or normalized steel; more for hardened steel, and less for aluminum.

X2.4.7 If  $F_{s_{max}}$  from (Eq X2.6) exceeds  $S_y A_s$ , use:

$$F_{s_{max}} = S_y A_s \quad (X2.7)$$

X2.4.8 If  $F_{s_{max}}$  from (Eq X2.6) or (Eq X2.7), whichever is the lower value, exceeds  $1.5 F_b$  from (Eq X2.3), select an intermediate value of  $F_s$ , preferably at least  $2 F_b$ , and calculate the required set-up torque as described in X2.3.

X2.4.9 If  $F_{s_{max}}$  from (Eq X2.6) or (Eq X2.7), whichever is the lower value, is less than  $1.5 F_b$  from (Eq X2.3), then the possibility of fatigue failure might be expected. Remedies to be considered are to use a specimen button with minimum thickness (4 mm), to use the alternative displacement amplitude of 25  $\mu\text{m}$  peak-to-peak, or to try one specimen to see whether it works. In any case, a preload force  $F_s$  of less than  $1.5 F_b$  should never be used.

### X3. RATIONALE

#### X3.1 Background and History:

X3.1.1 Ever since Gaines (2) discovered that cavitation erosion occurred at the face of a vibrating piston, this phenomenon has been used for basic research as well as for screening materials. In 1955 the American Society of Mechanical Engineers Committee on Cavitation recommended a standard test procedure based on the state-of-the-art then existent (3). Subsequently much advancement in test apparatus and techniques took place. Realizing this, ASTM Committee G02 initiated a round-robin test (4) in 1966, which was completed in 1969. The test specifications and recommendations contained in the first publication of this test method were the direct outcome of that ASTM round-robin test, although many of the participants in that test used existing apparatus with specimen diameters, amplitudes and frequencies that differed from the eventual standard. Similar test specifications had been proposed earlier by an independent group in the United Kingdom (5).

X3.1.2 The reasons for selecting the vibratory method for standardization were that it was widely used, relatively simple and inexpensive to set up, and readily controllable as to its important parameters. Other methods used for cavitation testing include the “cavitation tunnel” wherein cavitation is produced by flow through a venturi or past an obstruction, the “cavitating disc” method wherein a submerged rotating disc with holes or protrusions produces the cavitation, and, more recently, cavitating jet methods. Comprehensive references covering cavitation, cavitation damage and cavitation testing include Refs (6) through (10).

#### X3.2 Applications of Vibratory Apparatus:

X3.2.1 The vibratory method has been used, among other purposes, for studying the development of material damage (for example, Ref (9)), the influence of test parameters (for example, Refs (5), (11), and (12)), the dynamics of the “cavitation cloud” of bubbles and cavities (for example, Ref

(13)), cavitation in slurries (for example, Refs (14), (15)), and cavitation erosion-corrosion (for example, Refs (16), (17)).

X3.2.2 Numerous tests have been made with fluids other than water (such as glycerin, petroleum derivatives, mercury, sodium, etc.), and with water at various temperatures (for example, Refs (11), (12), (18), (19), (20), (21)).

X3.2.3 Tests using a stationary specimen in close proximity to the horn tip have been described by several authors (for example, Refs (14), (22), (23), (24), (25)), but inconsistent findings concerning optimum separation distance have discouraged standardization to date.

X3.3 Revisions to This Test Method—Subsequent to the first issue of this test method, revisions were minor or editorial in nature until after a “Workshop on Cavitation Erosion Testing” was held in 1987. This resulted in the establishment of a task group to review all facets of this test method, and to revise it thoroughly based on the latest experience with its use. The text has been almost completely revised and reorganized; however, except for the addition of an optional lower vibratory amplitude of 25  $\mu\text{m}$  (0.001 in.), and a slight increase in standard temperature from 22 to 25°C they will not change the results to be expected in a well-conducted test. The major change to the apparatus is that a larger liquid container is specified, and the immersion depth has been increased. The other revisions are intended to reduce variability by tightening the specifications of the test apparatus, setup, and procedures; to provide added guidance in use of this test method; and to further standardize the presentation of results. Also, the “standard reference material” has been changed from Nickel 270 to Nickel 200, because the former is no longer commercially available. A new interlaboratory study, using Nickel 200 and following the revised standard, was conducted in 1990–1991 and its results are the basis for a revised precision and bias statement.

**REFERENCES**

- (1) Peterson, R. E., *Stress Concentration Factors*, John Wiley and Sons, New York, NY, 1974.
- (2) Gaines, N., "A Magnetostriction Oscillator Producing Intense Audible Sound and Some Effects Obtained," *Physics*, Vol 3, No. 5, 1935, pp. 209–229.
- (3) Robinson, L. E., Holmes, B. A., and Leith, W. C., "Progress Report on Standardization of the Vibratory Cavitation Test," *Transactions, ASME*, Vol 80, 1958, pp. 103–107.
- (4) Hammitt, F. G., et al., "Round-Robin Test with Vibratory Cavitation and Liquid Impact Facilities of 6061-T 6511 Aluminum Alloy, 316 Stainless Steel and Commercially Pure Nickel," *Materials Research and Standards*, ASTM, Vol 10, No. 10, October 1970, pp. 16–36 (See also U.S. Government Clearinghouse Document No. PB 183 581.)
- (5) Hobbs, J. M., "Experience with a 20-kc Cavitation Erosion Test," *Erosion by Cavitation or Impingement, ASTM STP 408*, ASTM, 1967, pp. 159–185.
- (6) *ASME Symposium on Cavitation Research Facilities and Techniques*, American Society of Mechanical Engineers, New York, NY, 1964.
- (7) Knapp, R. T., Daily, J. W., and Hammitt, F. G., *Cavitation*, McGraw-Hill, 1970.
- (8) Preece, C. M., "Cavitation Erosion," *Treatise on Materials Science and Technology, Volume 16—Erosion*, Academic Press, 1979, pp. 249–308.
- (9) Preece, C. M., and Hansson, I., "A Metallurgical Approach to Cavitation Erosion," *Advances in the Mechanics and Physics of Surfaces*, Harwood Academic Publishers, 1981, 1, pp. 199–254.
- (10) Karimi, A., and Martin, J. L., "Cavitation Erosion of Materials," *International Metals Reviews*, Vol 31, No. 1, 1986, pp. 1–26.
- (11) Wiegand, H., and Schulmeister, R., "Investigations with Vibratory Apparatus on the Effect of Frequency, Amplitude, Pressure and Temperature on Cavitation Erosion [in German]," *MTZ Motortechnische Zeitschrift*, Vol 29, No. 2, 1968, pp. 41–50.
- (12) Matsumura, M., "Influence of Test Parameters in Vibratory Cavitation Erosion Tests," *Erosion: Prevention and Useful Applications, ASTM STP 664*, ASTM, 1979, pp. 434–458.
- (13) Hansson, I., and Morch, K. A., "Guide Vanes in the Vibratory Cavitation System to Improve Cavitation Erosion Testing," *Proceedings of the 6th International Conference on Erosion by Liquid and Solid Impact*, Cambridge University, UK, 1983, pp. 9-1 to 9-9.
- (14) Ji Zhiye, "A Study of Cavitation Damage in Slurry Flow," *Proceedings of the 7th International Conference on Liquid and Solid Impact*, Cambridge University, UK, 1987, pp. 35-1 to 35-7.
- (15) Matsumura, M., et al., "Vibratory Sand-Erosion Testing," *Proceedings of the 5th International Conference on Erosion by Liquid and Solid Impact*, Cambridge University, UK, 1979, pp. 53-1 to 53-6.
- (16) Oka, Y., and Matsumura, M., "Cavitation Erosion-Corrosion," *Proceedings of the 6th International Conference on Erosion by Liquid and Solid Impact*, Cambridge University, UK, 1983, pp. 11-1 to 11-10.
- (17) Hercamp, R. D., and Hudgens, R. D., "Cavitation Corrosion Bench Test for Engine Coolants," Paper No. 881269, Society of Automobile Engineers.
- (18) Devine, R. E., and Plesset, M. S., "Temperature Effects in Cavitation Damage," Report No. 85-27, Div. of Engr. and Applied Science, Calif. Inst. of Tech., Pasadena, CA, April 1964.
- (19) Garcia, R., Hammitt, F. G., and Nystrom, R. E., "Comprehensive Cavitation Damage Data for Water and Various Liquid Metals Including Correlations with Material and Fluid Properties," *Erosion by Cavitation or Impingement, ASTM STP 408*, ASTM, 1967, pp. 239–279.
- (20) Hammitt, F. G., and Rogers, D. O., "Effects of Pressure and Temperature Variation in Vibratory Cavitation Damage Test," *Journal of Mechanical Engineering Science*, Vol 12, No. 6, 1970, pp. 432–439.
- (21) Young, S. G., and Johnston, J. R., "Effect of Temperature and Pressure on Cavitation Damage in Sodium," *Characterization and Determination of Erosion Resistance, ASTM STP 474*, ASTM, 1971, pp. 67–102.
- (22) Endo, K., Okada, T., and Nakashima, M., "A Study of Erosion Between Two Parallel Surfaces Oscillating at Close Proximity in Liquids," *ASME Transactions*, Vol 89, Series F, *Journal of Lubrication Technology*, 1967, pp. 229–236.
- (23) Hobbs, J. M., and Rachman, D., "Environmentally Controlled Cavitation Test (Improvement in a Cavitating Film Erosion Test)," *Characterization and Determination of Erosion Resistance, ASTM STP 474*, ASTM, 1970, pp. 29–47.
- (24) Hansson, I., and Morch, K. A., "Some Aspects on the Initial Stage of Ultrasonically Induced Cavitation Erosion," *Proc. Ultrasonic International*, Graz, Austria, IPC Science and Technology Press, UK, 1979, pp. 221–226.
- (25) Matsumura, M., Okumoto, S., and Saga, Y., "Mechanism of Damage in the Vibratory Test with Stationary Specimen," *Bulletin of the Japan Society of Mechanical Engineers*, Vol 25, No. 204, 1982, pp. 898–905.

ASTM International takes no position respecting the validity of any patent rights asserted in connection with any item mentioned in this standard. Users of this standard are expressly advised that determination of the validity of any such patent rights, and the risk of infringement of such rights, are entirely their own responsibility.

This standard is subject to revision at any time by the responsible technical committee and must be reviewed every five years and if not revised, either reapproved or withdrawn. Your comments are invited either for revision of this standard or for additional standards and should be addressed to ASTM International Headquarters. Your comments will receive careful consideration at a meeting of the responsible technical committee, which you may attend. If you feel that your comments have not received a fair hearing you should make your views known to the ASTM Committee on Standards, at the address shown below.

This standard is copyrighted by ASTM International, 100 Barr Harbor Drive, PO Box C700, West Conshohocken, PA 19428-2959, United States. Individual reprints (single or multiple copies) of this standard may be obtained by contacting ASTM at the above address or at 610-832-9585 (phone), 610-832-9555 (fax), or service@astm.org (e-mail); or through the ASTM website (www.astm.org).