



Standard Practice for Design of Articles to Be Electroplated on Racks¹

This standard is issued under the fixed designation B 507; the number immediately following the designation indicates the year of original adoption or, in the case of revision, the year of last revision. A number in parentheses indicates the year of last reapproval. A superscript epsilon (ϵ) indicates an editorial change since the last revision or reapproval.

1. Scope

1.1 This practice covers design information for parts to be electroplated on racks. The recommendations contained herein are not mandatory, but are intended to give guidance toward good practice.

1.2 *This standard does not purport to address all of the safety concerns, if any, associated with its use. It is the responsibility of the user of this standard to establish appropriate safety and health practices and determine the applicability of regulatory limitations prior to use.*

2. Significance and Use

2.1 When an article is to be electroplated, it is necessary to consider not only the characteristics of the electroplating process, but also the design of the part to minimize electroplating and finishing costs and solution dragout as well as to improve appearance and functionality. It is often possible during the design and engineering stages to make small adjustments in shape that will result in considerable benefit toward a better quality part at a lower cost.

2.2 The specific property of an electroplating process that would require some attention to the details of optional designs, is the throwing power of the electroplating solution. Throwing power is the improvement of the coating distribution over the primary current distribution on an electrode (usually cathode) in a given solution, under specified conditions.

3. Current Distribution and Throwing Power

3.1 The apparent current during practical electroplating is never uniform over the surface of the product. Even parallel plates have a nonuniform distribution of current when freely suspended in a bath as shown in Fig. 1. In this example, the current lines tend to concentrate at corners, and edges (high-current density) of the part. Consequently more metal is deposited at the high-current density areas than at the low-current density areas.

4. Relative Throwing Powers of Different Electrolytes

4.1 Throwing power is not the same for all metals and all electroplating baths. Table 1 lists the commonly used electroplating processes. They are arranged according to decreasing throwing power.

4.2 A Rochelle-type copper electroplating solution has excellent throwing power compared to the poor throwing power of a chromic acid solution used to deposit chromium. The widely used Watts-type nickel bath has fair throwing power.

5. Geometric Factors Determining Deposit Distribution

5.1 Since a metal deposits preferentially at protuberances, such as sharp corners, edges, fins, and ribs, these should be rounded to a radius of at least 0.4 and preferably 0.8 mm to avoid excessive buildup. Contouring a base corner in a depression is also recommended to avoid thickness deficiency at the location.

5.2 The width-to-depth ratio of a depression or recess should be held to more than three as shown in Fig. 2. Otherwise, a special auxiliary anode must be employed inside the recess to promote more uniform current distribution. An auxiliary anode is usually made of the depositing metal and is placed close to the low-current density areas to enhance metal deposition at those regions.

5.3 All sharp edges and base angles of a recess should be rounded to a radius of 0.25 times or more the depth of the recess as shown in Fig. 3. When sharp recess angles are required for a functional purpose, the electroplater cannot be expected to meet a minimum thickness at those locations unless it is specifically required.

6. Examples of Distribution of Electrodeposited Nickel on Various Shapes

6.1 Fig. 4 through Fig. 5² show the kind of nickel distribution that was obtained on several different cathode configurations as deposited from a Watts-type bath at normal operating current densities. The thicknesses illustrated are exaggerated to emphasize the variations that were obtained. The data are

¹ This practice is under the jurisdiction of ASTM Committee B08 on Metallic and Inorganic Coatings and is the direct responsibility of Subcommittee B08.01 on Ancillary Activities.

Current edition approved Feb. 10, 2003. Published May 2003. Originally approved in 1970. Last previous edition approved in 1998 as B 507 – 86 (1998).

² Adapted from sketches appearing in *Electroplating and Engineering Handbook*, 4th ed, Durney, L. J., ed., Reinhold Publishing Corporation, New York, 1984.

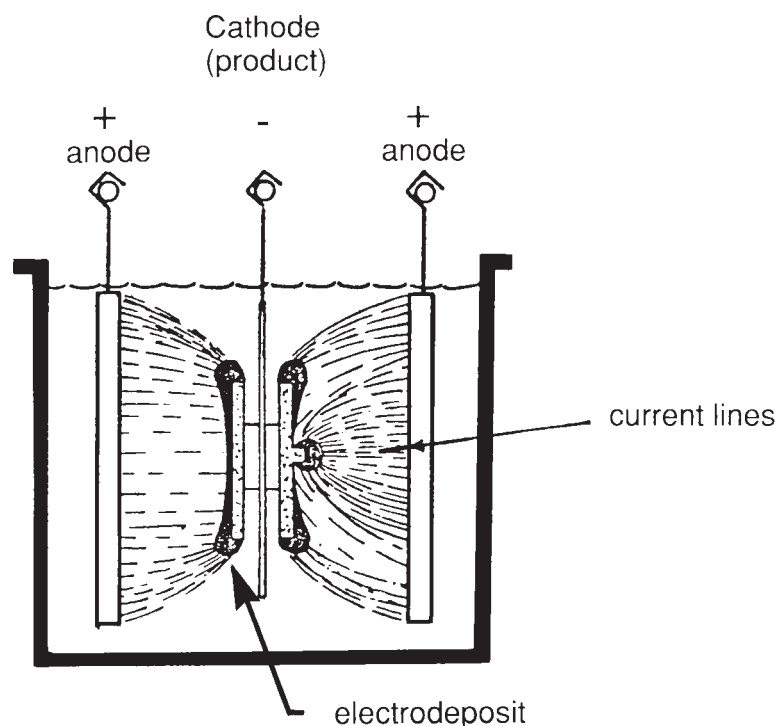

FIG. 1 Current Density Distribution and Typical Electrodeposit (filled area)

TABLE 1 Relative Throwing Powers of Common Electroplating Baths

Bath/Metal	Ranking
Rochell copper (cyanide based)	Excellent
Cyanide cadmium	Excellent
Cyanide gold	Good
Cyanide silver	Good
Alkaline tin	Good
Cyanide zinc	Good
Alkaline non cyanide zinc	Good
Fluoroborate lead	Good
All chloride nickel	Fair
Tin nickel	Fair
Sulfamate nickel	Fair
Watts nickel ^A	Fair
Bright nickel	Fair
Acid chloride zinc	Fair
Nickel-iron	Fair
Chloride iron	Fair
Pyrophosphate copper	Fair
Acid copper	Fair
Trivalent chromium	Poor
Hexavalent chromium	Poor

^A Used for examples illustrated by Figs. 4-5.

measurements taken from metallographic cross sections. Reference to the figures enables similar conclusions to be drawn with most other metals, excluding chromium. The ranges will be smaller for metals above nickel in Table 1 and larger for metals below nickel.

6.2 Improvement in nickel distribution can be gained inside an angle by increasing the angle size, as shown in Fig. 4. Two surfaces meeting at an angle of 60° show an average-to-minimum thickness ratio of 3.3, and increasing the angle to 90° or 120° the ratio can be reduced to 2.7 or 1.9, respectively.

6.3 Sharp corners should be given as large a radius as practical to improve metal distribution in a recess and avoid

excessive buildup on protuberances. Fig. 6(a) illustrates a part with a sharp angled recess. Nickel distribution is not very uniform with practically no deposit down in the corners of the recess. Rounding the corners of the recess on the part, as shown in Fig. 6(b), yields a more uniform nickel thickness in the recess. The average-to-minimum thickness ratio in these examples was 9.2 for the part with sharp corners and 5.6 for the part with the rounded corners.

6.4 Deep recesses will always have a thinner deposit than the surrounding external areas, as shown in the cross section of a concave part in Fig. 7(a). The average-to-minimum nickel thickness ratio for this example was 6.6. A more uniform deposit thickness can be obtained on a convex-shaped part, as shown in the example of Fig. 7(b). In this case the average-to-minimum nickel thickness ratio was 2.

6.5 Another example of an elongated curved surface (convex) is illustrated in Fig. 5(a). The nickel deposit was fairly uniform with an indicated average-to-minimum thickness ratio of 2. However, when this shape is joined to another like a flat plate, metal distribution is considerably different as illustrated by Fig. 5(b).

7. Racking and Rinsing

7.1 Other factors besides metal distribution should also be taken into account when designing a part that will be rack electroplated. The parts must be attached firmly to the rack, so that all significant surfaces come in contact with the electrolyte.

7.2 The parts must be attached to a rack firmly enough to prevent falling off during electroplating, and the attachment should be with enough force to provide a continual low-resistance electrical contact. In many cases, parts are rigidly fastened to racks through spring clips, prongs or bolts. Little or

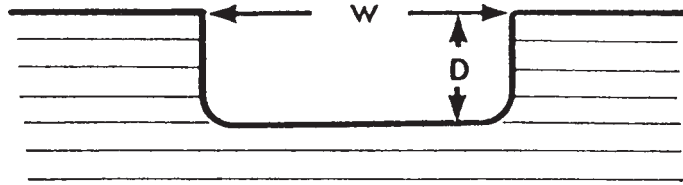

NOTE 1—Ratio should be a minimum of three

FIG. 2 Width-to-Depth Ratio of a Recess

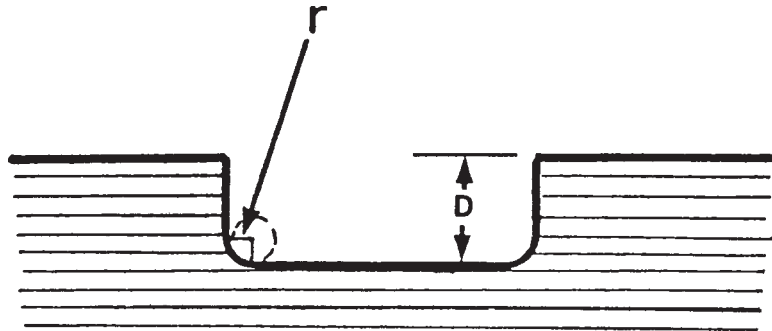
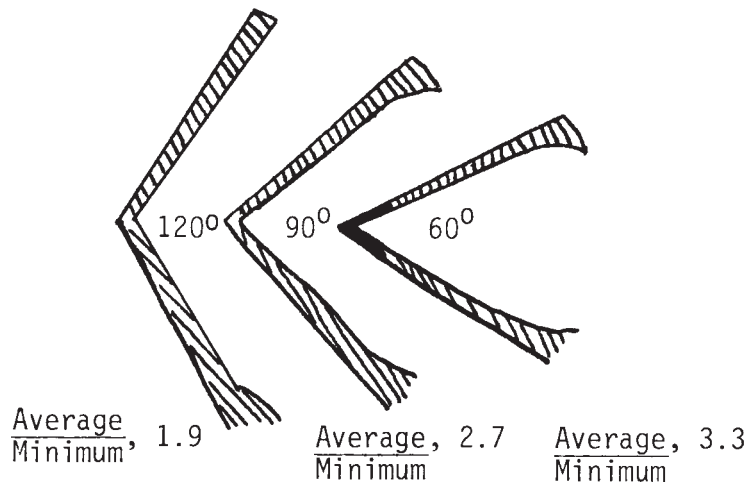

FIG. 3 Rounding Corners to a Radius (r) Related to the Depth of a Recess, $r > 0.25D$



NOTE—Adapted from sketches appearing in *Electroplating and Engineering Handbook*, 3rd ed. Reinhold Publishing Corporation, Graham, A. K., and Pinkerton, H. L., eds., New York, 1971.

FIG. 4 Influence of Increasing Angle to Improve Thickness Distribution of Electrodeposited Nickel

no metal will desposit at the points of contact; therefore, it is important to select noncritical areas for attaching parts to racks.

7.3 Articles attached to racks should be oriented to permit electroplating to be free of roughness on significant surfaces. Roughness comes from insoluble debris suspended in an electroplating bath that becomes incorporated into the depositing metal, especially on upward facing surfaces. Thus, in many circumstances, it is advisable to have the significant surfaces in a vertical position, or even be inverted during electroplating.

7.4 Orientation of a part on a rack is also important to reduce opportunities for air entrapment in cupped areas. Air pockets will prevent metal deposition on the exposed surface. Adequate drainage of parts on racks is also desirable to reduce dragout of the electrolyte to the rinses. Engineering design can incorporate holes at strategic locations to allow satisfactory runoff of solution.

Maximum - 69 μm - Minimum - 18 μm

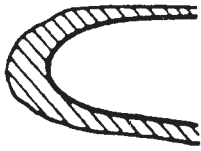

Average - 36 μm - Ratio $\frac{\text{Average}}{\text{Minimum}}$ - 2.0

- A -



Maximum - 65 μm

Minimum - 2.5 μm

Average - 23 μm

Ratio $\frac{\text{Average}}{\text{Minimum}}$ - 9.2

- A -

Maximum - 56 μm - Minimum - 2.5 μm

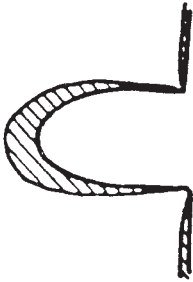

Average - 20 μm - Ratio $\frac{\text{Average}}{\text{Minimum}}$ - 8.0

- B -



Maximum - 81 μm

Minimum - 5 μm

Average - 28 μm

Ratio $\frac{\text{Average}}{\text{Minimum}}$ - 5.6

- B -

FIG. 5 Nickel Distribution on a Convex Surface (a) alone Compared to the Same Configuration as Part of a Larger Composite (b)

FIG. 6 Improving Nickel Thickness Distribution (Average/Minimum Thickness Ratio) by Rounding Corners

Maximum - 96 μm - Minimum - 5 μm

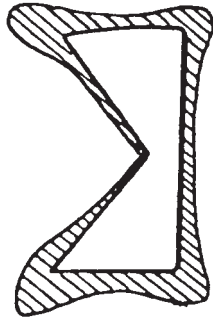

- A -

Average - 33 μm - Ratio $\frac{\text{Average}}{\text{Minimum}}$ - 6.6

Maximum - 69 μm

Minimum - 15 μm

Average - 30 μm

Ratio $\frac{\text{Average}}{\text{Minimum}}$ - 2.0

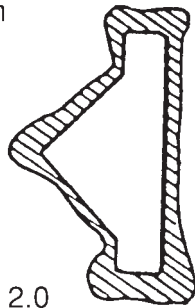

- B -

FIG. 7 Comparing Nickel Distribution on Concave (a) and Convex (b) Surfaces

ASTM International takes no position respecting the validity of any patent rights asserted in connection with any item mentioned in this standard. Users of this standard are expressly advised that determination of the validity of any such patent rights, and the risk of infringement of such rights, are entirely their own responsibility.

This standard is subject to revision at any time by the responsible technical committee and must be reviewed every five years and if not revised, either reapproved or withdrawn. Your comments are invited either for revision of this standard or for additional standards and should be addressed to ASTM International Headquarters. Your comments will receive careful consideration at a meeting of the responsible technical committee, which you may attend. If you feel that your comments have not received a fair hearing you should make your views known to the ASTM Committee on Standards, at the address shown below.

This standard is copyrighted by ASTM International, 100 Barr Harbor Drive, PO Box C700, West Conshohocken, PA 19428-2959, United States. Individual reprints (single or multiple copies) of this standard may be obtained by contacting ASTM at the above address or at 610-832-9585 (phone), 610-832-9555 (fax), or service@astm.org (e-mail); or through the ASTM website (www.astm.org).